

**CONNETTORI MULTIPOLARI SERIE CVB-EX e CVBM-EX****MULTIPOLE CONNECTOR CVB-EX and CVBM-EX**

Determinazione della massima corrente ammissibile (Amp) per ogni dimensione di contatto in funzione della temperatura ambiente e della classe di temperatura del connettore per **montaggio su custodie Ex d**.

*Determination of max admissible current (Amps) for each contact size depending on ambient temperature and temperature class of connector for **mounting on Ex d equipments**.*

Tamb		≤ 60°C	70°C	90°C	110°C	120°C		
Classe temp.		T6	T6	T5	T5	T4	T4	
Grandezza contatto Contact size	20	3	1,5	3	1,5	3	1,5	0,75
	18	6	3	6	3	6	3	1,5
	16S	10	5	10	5	10	5	2,5
	16	10	5	10	5	10	5	2,5
	12	20	10	20	10	20	10	5
	8	40	20	40	20	40	20	10
	4	63	31,5	63	31,5	63	31,5	15,5
	0	125	62,5	125	62,5	125	62,5	31

Determinazione della massima corrente ammissibile (Amp) per ogni dimensione di contatto in funzione della temperatura ambiente e della classe di temperatura del connettore per **montaggio su custodie Ex e / Ex p**.

*Determination of max admissible current (Amps) for each contact size depending on ambient temperature and temperature class of connector for **mounting on Ex e / Ex p equipments**.*

Tamb		40°C		60°C		80°C		90°C		110°C	120°C
Classe temp.		T6	T5	T6	T4	T5	T4	T5	T4	T4	T4
Grandezza contatto Contact size	20	1,5	3	1,5	3	1,5	3	0,75	1,5	1,5	0,75
	18	3	6	3	6	3	6	1,5	3	3	1,5
	16S	5	10	5	10	5	10	2,5	5	5	2,5
	16	5	10	5	10	5	10	2,5	5	5	2,5
	12	10	20	10	20	10	20	5	10	10	5
	8	20	40	20	40	20	40	10	20	20	10
	4	31,5	63	31,5	63	31,5	63	15,5	31,5	31,5	15,5
	0	62,5	125	62,5	125	62,5	125	31	62,5	62,5	31



SCHEMI MONTAGGIO CONNETTORI CVB-EX e CVBM-EX

TIPIC of MOUNTING CONNECTOR CVB-EX and CVBM-EX

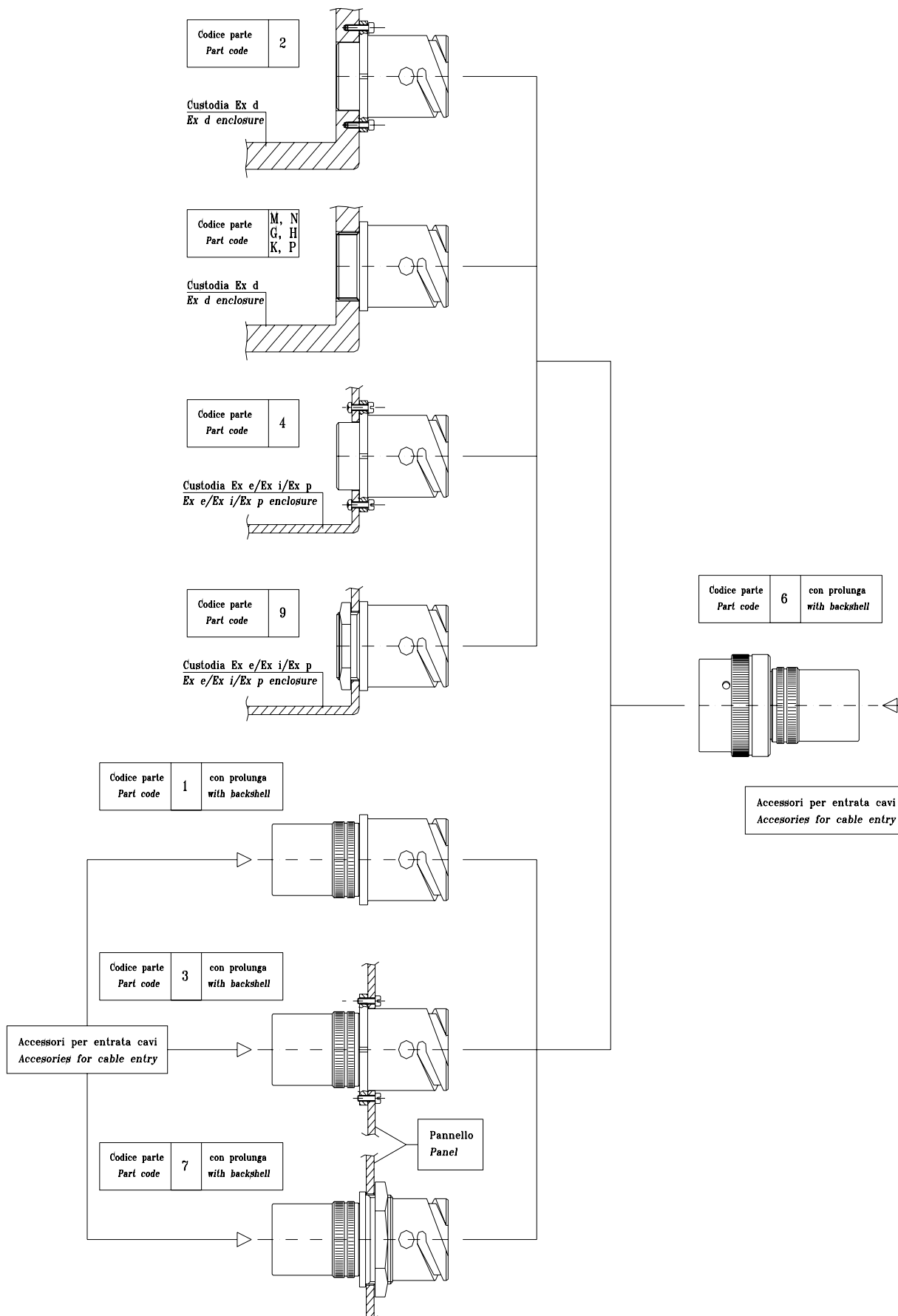

**SCHEMI MONTAGGIO CONNETTORI CVB-EX e CVBM-EX****TIPIC of MOUNTING CONNECTOR CVB-EX and CVBM-EX**

Codice parte <i>Part code</i>	Idoneo per custodie <i>Suitable for enclosures</i>				Montaggio a pannello <i>Panel mount</i>	Connessione volante <i>Inline connection</i>	Configurazione fornita <i>Supply condition</i>	
	Ex d	Ex e	Ex p	Ex i			standard	opzionale
M, N	✓	✓	✓	✓	no	no	A	no
4, 9	no	✓	✓	✓	no	no	B	A
3, 7	no	no	no	no	✓	✓	B	A
1	no	no	no	no	no	✓	B	A
6	no	no	no	no	no	✓	B	A
2 ⁽¹⁾	✓	✓	✓	✓	no	no	A	no
G, H, K, P ⁽²⁾	✓	✓	✓	✓	no	no	A	no

A: fornito completo di cablaggio e resinatura – *supplied completely wired and potted*

B: cablaggio e resinatura a cura dell'utente – *wiring and potting made by user*

⁽¹⁾ soggetto a particolari condizioni di utilizzo – *special conditions apply*

⁽²⁾ esecuzioni disponibili a richiesta – *models available on request*

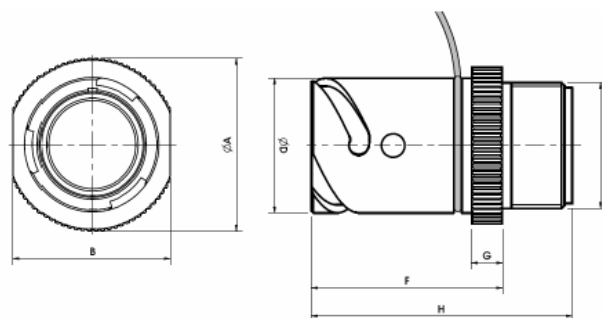
Codice parte G, H, K, M, N, P

Size	A	B	C*	ΦD	F	G	H
14S	32		20	24,6			
16S	37	32	25	27,4	40,6	6,5	53,8
18	40	34	28	30,8	45,1	8	66,8
20	44	40	32	34,2	45,1	8	66,8
22	44	40	36	37,4			
24	54		40	40,9			
28	56		44	46,7			
32	62		50	53,4			
36	66		56	59,6			
40	75		63	65,5			

* Il valore indicato si riferisce alla dimensione convenzionale di filettatura riportato nella tabella a pag. L4
Value refers to conventional thread dimension as indicated in table page L4



DIMENSIONI CONNETTORI CVB-EX e CVBM-EX

DIMENSIONS CONNECTOR CVB-EX and CVBM-EX



Codice parte 4 (2)

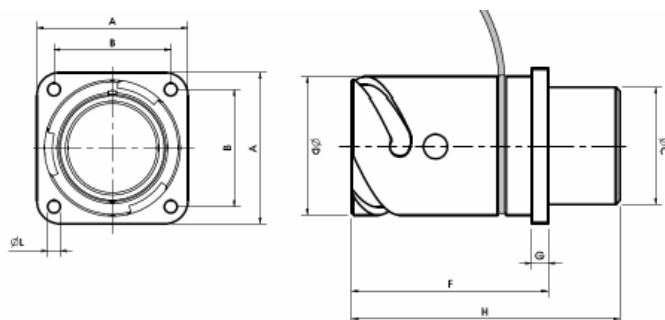

Size	A	B	C	ΦD	F	G	ΦL	H
14S	30,2	23	19,2	24,6		3,4	3,1	
16S	32,5	24,6	22,4	27,4		3,2	3,1	
18	34,9	27	25,6	30,8	45,1	4	3,1	63,1
20	38,1	29,4	28,8	34,2	45,1	4	3,1	63,1
22	41	31,8	32,2	37,4		4	3,1	
24	44,5	34,9	35,2	40,9		4	3,7	
28	50,8	39,7	41,5	46,7		4	3,7	
32	57	44,5	47,8	53,4		4	4,4	
36	63,5	49,2	52,6	59,6		4	4,4	
40	69,8	55,6	59,2	65,5		4	4,4	

Codice parte 6

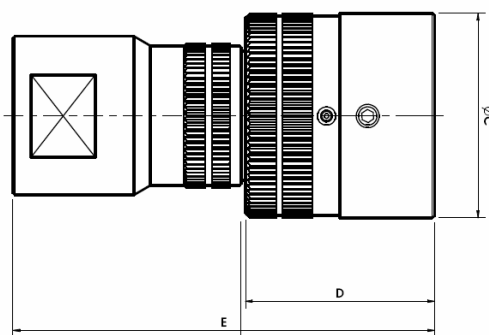



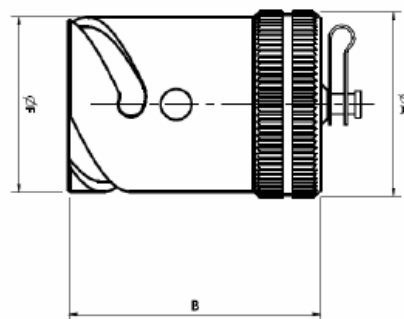
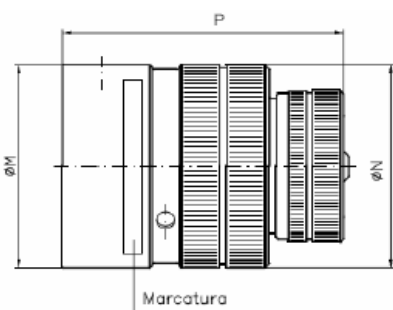
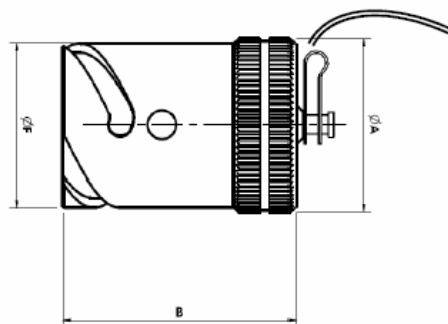
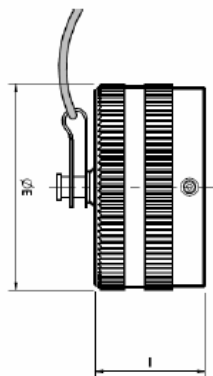

DIMENSIONI CONNETTORI CVB-EX e CVBM-EX

DIMENSIONS CONNECTOR CVB-EX and CVBM-EX



	DISPOSIZIONE CONTATTI	
	CONTACTS LAYOUT	

INSERTI ISOLANTI E ZOCCOLI

INSULATING INSERTS AND GROMMETS

Elenco per quantità totale di contatti

List by contacts total quantity

1 contatto
1 contact

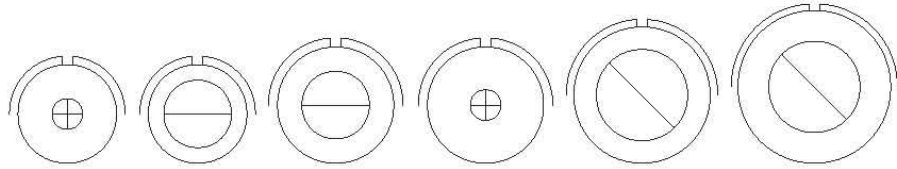

DISPOSIZIONE INSERTO <i>ARRANGEMENT</i>	16-2	16-12	18-6	18-16	20-2	22-7
NUMERO CONTATTI <i>NO. OF CONTACTS</i>	1	1	1	1	1	1
MISURA CONTATTO <i>CONTACT SIZE</i>	12	4	4	12	0	0
CODICE SERVIZIO <i>SERVICE RATING</i>	E	A	D	C	D	E

2 contatti
2 contacts

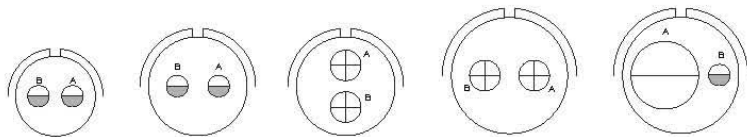

DISPOSIZIONE INSERTO <i>ARRANGEMENT</i>	14S-9	16S-4	16-11	18-3	18-14
NUMERO CONTATTI <i>NO. OF CONTACTS</i>	2	2	2	2	2
MISURA CONTATTO <i>CONTACT SIZE</i>		16	16	12	1-4, 1-16
CODICE SERVIZIO <i>SERVICE RATING</i>		A	D	A	D

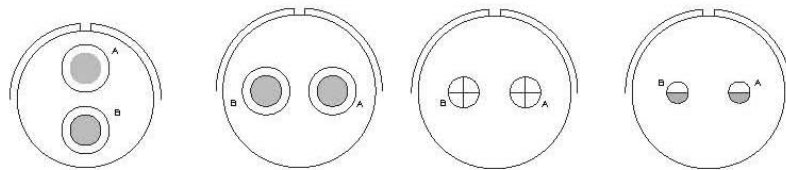

DISPOSIZIONE INSERTO <i>ARRANGEMENT</i>	20-23	22-1	22-8	22-11
NUMERO CONTATTI <i>NO. OF CONTACTS</i>	2	2	2	2
MISURA CONTATTO <i>CONTACT SIZE</i>	2-8	2-8	2-12	2-16
CODICE SERVIZIO <i>SERVICE RATING</i>	A	D	E	B

Vista frontale inserto contatti maschi



Front view male contacts insert



Legenda contatti

20 18 16 12 8 4 0

Contacts legend

	DISPOSIZIONE CONTATTI	
	CONTACTS LAYOUT	

INSERTI ISOLANTI E ZOCCOLI

INSULATING INSERTS AND GROMMETS

Elenco per quantità totale di contatti

List by contacts total quantity

2 contatti
2 contacts

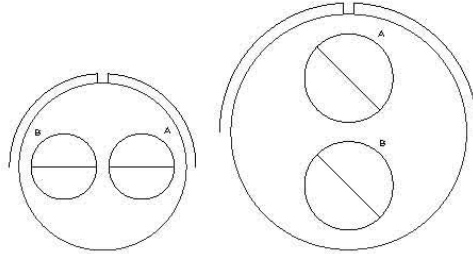

DISPOSIZIONE INSERTO <i>ARRANGEMENT</i>	24-9	32-5
NUMERO CONTATTI <i>NO. OF CONTACTS</i>	2	2
MISURA CONTATTO <i>CONTACT SIZE</i>	2-4	2-0
CODICE SERVIZIO <i>SERVICE RATING</i>	A	D

3 contatti
3 contacts

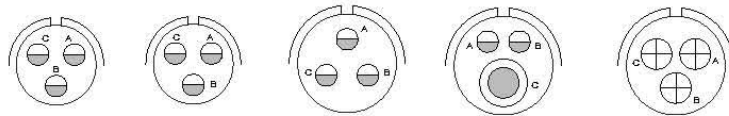

DISPOSIZIONE INSERTO <i>ARRANGEMENT</i>	14S-1	14S-7	16S-5	16-7	16-10
NUMERO CONTATTI <i>NO. OF CONTACTS</i>	3	3	3	3	3
MISURA CONTATTO <i>CONTACT SIZE</i>	3-16	3-16	3-16	1-8, 2-16	3-12
CODICE SERVIZIO <i>SERVICE RATING</i>	A	A	A	A	A

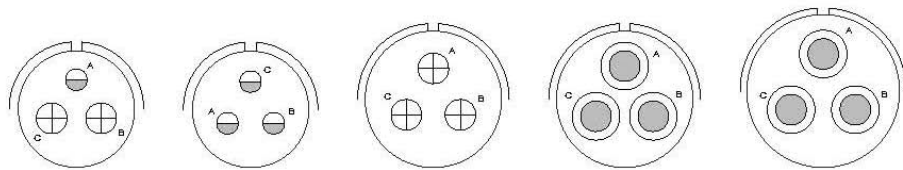

DISPOSIZIONE INSERTO <i>ARRANGEMENT</i>	18-5	18-22	20-3	20-19	22-2
NUMERO CONTATTI <i>NO. OF CONTACTS</i>	3	3	3	3	3
MISURA CONTATTO <i>CONTACT SIZE</i>	2-12, 1-16	3-16	3-12	3-8	3-8
CODICE SERVIZIO <i>SERVICE RATING</i>	D	D	D	A	D

Vista frontale inserto contatti maschi

Front view male contacts insert



Legenda contatti

20

18

16



12

8

4

0

Contacts legend

	DISPOSIZIONE CONTATTI	
	CONTACTS LAYOUT	

INSERTI ISOLANTI E ZOCCOLI

INSULATING INSERTS AND GROMMETS

Elenco per quantità totale di contatti

List by contacts total quantity

3 contatti
3 contacts

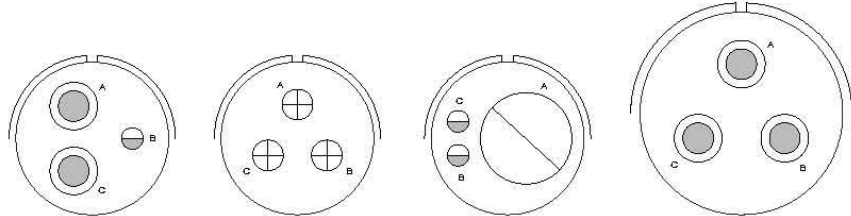

DISPOSIZIONE INSERTO <i>ARRANGEMENT</i>	22-6	22-9	22-21	28-3
NUMERO CONTATTI <i>NO. OF CONTACTS</i>	3	3	3	3
MISURA CONTATTO <i>CONTACT SIZE</i>	2-8, 1-16	8-12	1-0, 2-16	3-8
CODICE SERVIZIO <i>SERVICE RATING</i>	D	E	A	E

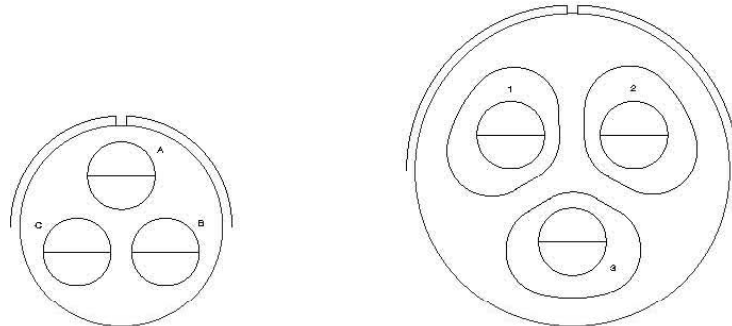

DISPOSIZIONE INSERTO <i>ARRANGEMENT</i>	28-6	40A-3
NUMERO CONTATTI <i>NO. OF CONTACTS</i>	3	3
MISURA CONTATTO <i>CONTACT SIZE</i>	3-4	3-4
CODICE SERVIZIO <i>SERVICE RATING</i>	D	E

4 contatti
4 contacts

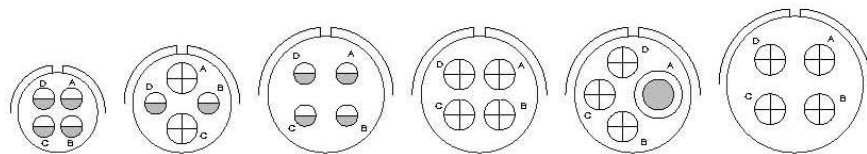

DISPOSIZIONE INSERTO <i>ARRANGEMENT</i>	14S-2	16-9	18-4	18-10	18-13	20-4
NUMERO CONTATTI <i>NO. OF CONTACTS</i>	4	4	4	4	4	4
MISURA CONTATTO <i>CONTACT SIZE</i>	4-16	2-12, 2-16	4-16	4-12	1-8, 3-12	4-12
CODICE SERVIZIO <i>SERVICE RATING</i>	I	A	D	A	A	D

Vista frontale inserto contatti maschi



Front view male contacts insert



Legenda contatti

20 18 16 12 8 4 0

Contacts legend

	DISPOSIZIONE CONTATTI	
	CONTACTS LAYOUT	

INSERTI ISOLANTI E ZOCCOLI

INSULATING INSERTS AND GROMMETS

Elenco per quantità totale di contatti

List by contacts total quantity

4 contatti
4 contacts

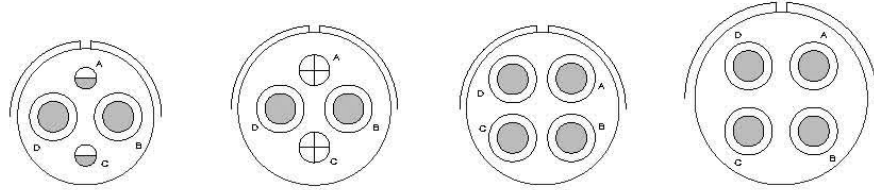

DISPOSIZIONE INSERTO <i>ARRANGEMENT</i>	20-24	22-4	22-22	24-22
NUMERO CONTATTI <i>NO. OF CONTACTS</i>	4	4	4	4
MISURA CONTATTO <i>CONTACT SIZE</i>	2-8, 2-16	2-8, 2-12	4-8	4-8
CODICE SERVIZIO <i>SERVICE RATING</i>	A	A	A	D

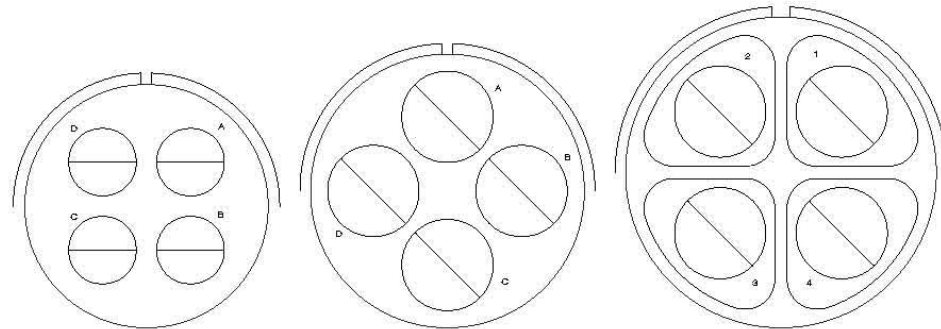

DISPOSIZIONE INSERTO <i>ARRANGEMENT</i>	32-17	36-5	40A-4
NUMERO CONTATTI <i>NO. OF CONTACTS</i>	4	4	4
MISURA CONTATTO <i>CONTACT SIZE</i>	4-4	4-0	4-0
CODICE SERVIZIO <i>SERVICE RATING</i>	D	A	E

5 contatti
5 contacts

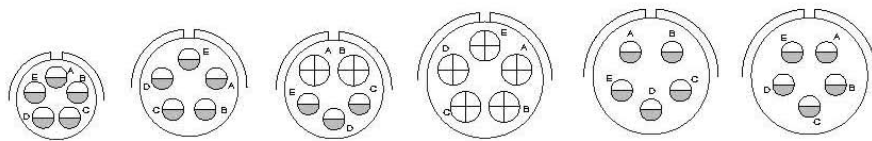

DISPOSIZIONE INSERTO <i>ARRANGEMENT</i>	14S-5	16S-8	16A-5	18-11	18-20	18A-5
NUMERO CONTATTI <i>NO. OF CONTACTS</i>	5	5	5	5	5	5
MISURA CONTATTO <i>CONTACT SIZE</i>	5-16	5-16	2-12, 3-16	5-12	5-16	5-16
CODICE SERVIZIO <i>SERVICE RATING</i>	I	A	*	A	A	(*)



☐ Consultare l'Ufficio Vendite

(*) Consult our Sales Office

Vista frontale inserto contatti maschi

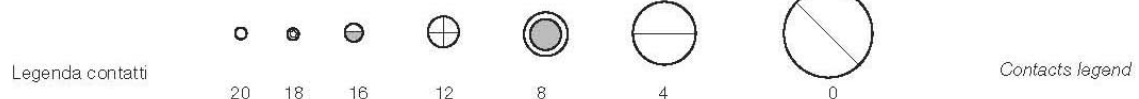
Front view male contacts insert



	DISPOSIZIONE CONTATTI	
	CONTACTS LAYOUT	

INSERTI ISOLANTI E ZOCCOLI

INSULATING INSERTS AND GROMMETS

Elenco per quantità totale di contatti

List by contacts total quantity

5 contatti
5 contacts

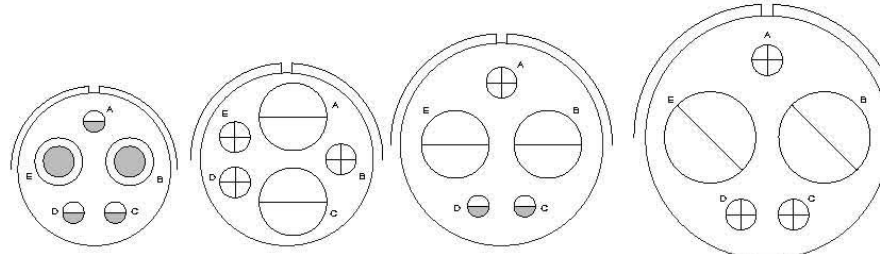

DISPOSIZIONE INSERTO <i>ARRANGEMENT</i>	22-12	24-12	28-5	32-1
NUMERO CONTATTI <i>NO. OF CONTACTS</i>	5	5	5	5
MISURA CONTATTO <i>CONTACT SIZE</i>	2-8, 3-16	2-4, 3-12	2-4, 1-12, 2-16	2-0, 3-12
CODICE SERVIZIO <i>SERVICE RATING</i>	D	A D	A=E - Bal.=D	

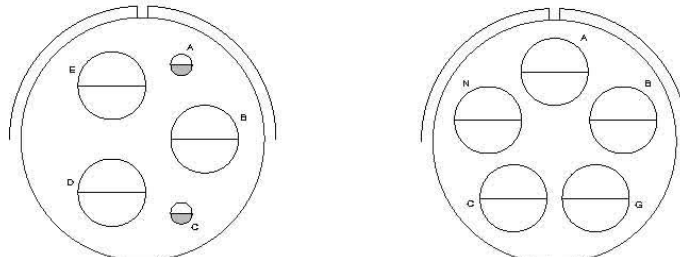

DISPOSIZIONE INSERTO <i>ARRANGEMENT</i>	32-2	32A-5
NUMERO CONTATTI <i>NO. OF CONTACTS</i>	5	5
MISURA CONTATTO <i>CONTACT SIZE</i>	3-4, 2-16	5-4
CODICE SERVIZIO <i>SERVICE RATING</i>	E	(*)

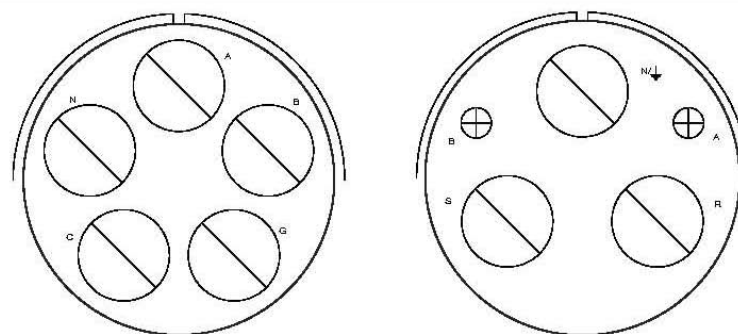

DISPOSIZIONE INSERTO <i>ARRANGEMENT</i>	40A-5	40B-3
NUMERO CONTATTI <i>NO. OF CONTACTS</i>	5	5
MISURA CONTATTO <i>CONTACT SIZE</i>	5-0	3-0, 2-12
CODICE SERVIZIO <i>SERVICE RATING</i>	(*)	A

☐ Consultare l'Ufficio Vendite

☐ Consult our Sales Office

Vista frontale inserto contatti maschi



Front view male contacts insert



Legenda contatti

20 18 16 12 8 4 0

Contacts legend

	DISPOSIZIONE CONTATTI	
	CONTACTS LAYOUT	

INSERTI ISOLANTI E ZOCCOLI

INSULATING INSERTS AND GROMMETS

Elenco per quantità totale di contatti

List by contacts total quantity

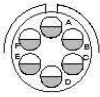
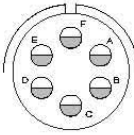
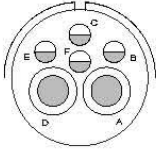
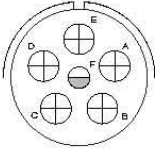
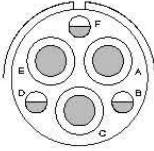
6 contatti 6 contacts					
	DISPOSIZIONE INSERTO <i>ARRANGEMENT</i>	14S-6	18-12	20-8	20-17
NUMERO CONTATTI <i>NO. OF CONTACTS</i>	6	6	6	6	6
MISURA CONTATTO <i>CONTACT SIZE</i>	6-16	6-16	2-8, 4-16	5-12, 1-16	3-8, 3-16
CODICE SERVIZIO <i>SERVICE RATING</i>	I	A	I	A	A

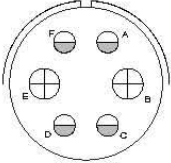
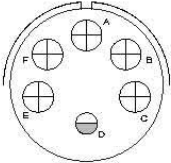
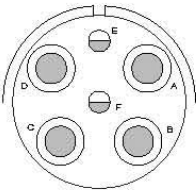
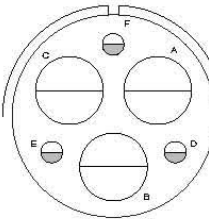
				
DISPOSIZIONE INSERTO <i>ARRANGEMENT</i>	22-5	22-15	24-06	28-22
NUMERO CONTATTI <i>NO. OF CONTACTS</i>	6	6	6	6
MISURA CONTATTO <i>CONTACT SIZE</i>	2-12, 4-16	5-12, 1-16	4-8, 2-16	3-4, 3-16
CODICE SERVIZIO <i>SERVICE RATING</i>	D	D=E - Bal.=A	D	D

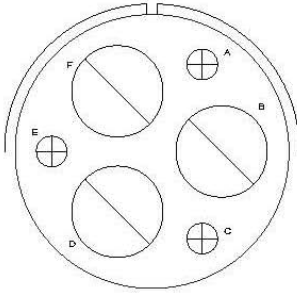
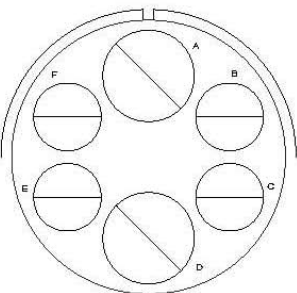
		
DISPOSIZIONE INSERTO <i>ARRANGEMENT</i>	36-3	36-6
NUMERO CONTATTI <i>NO. OF CONTACTS</i>	6	6
MISURA CONTATTO <i>CONTACT SIZE</i>	3-0, 3-12	2-0, 4-4
CODICE SERVIZIO <i>SERVICE RATING</i>	D	A

Vista frontale inserto contatti maschi

Front view male contacts insert



Legenda contatti

20

18

16



12

8

4

0

Contacts legend

	DISPOSIZIONE CONTATTI	
	CONTACTS LAYOUT	

INSERTI ISOLANTI E ZOCCOLI

Elenco per quantità totale di contatti

INSULATING INSERTS AND GROMMETS

List by contacts total quantity

7 contatti
7 contacts

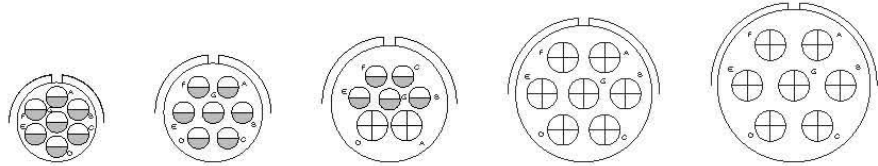

DISPOSIZIONE INSERTO <i>ARRANGEMENT</i>	14SA-7	16S-1	18-9	20-15	22-28
NUMERO CONTATTI <i>NO. OF CONTACTS</i>	7	7	7	7	7
MISURA CONTATTO <i>CONTACT SIZE</i>	7-16	7-16	2-12, 5-16	7-12	7-12
CODICE SERVIZIO <i>SERVICE RATING</i>	I	A	I	A	A

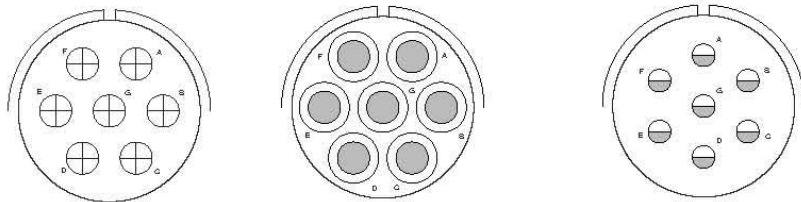

DISPOSIZIONE INSERTO <i>ARRANGEMENT</i>	24-2	24-10	24-27
NUMERO CONTATTI <i>NO. OF CONTACTS</i>	7	7	7
MISURA CONTATTO <i>CONTACT SIZE</i>	7-12	7-8	7-16
CODICE SERVIZIO <i>SERVICE RATING</i>	D	A	E

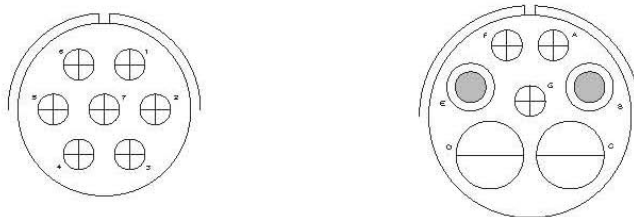

DISPOSIZIONE INSERTO <i>ARRANGEMENT</i>	24A-7	28-10
NUMERO CONTATTI <i>NO. OF CONTACTS</i>	7	7
MISURA CONTATTO <i>CONTACT SIZE</i>	7-12	2-4, 3-8, 3-12
CODICE SERVIZIO <i>SERVICE RATING</i>	D	G=D, Bal.=A

Vista frontale inserto contatti maschi



Front view male contacts insert



Legenda contatti

20 18 16 12 8 4 0

Contacts legend

	DISPOSIZIONE CONTATTI	
	CONTACTS LAYOUT	

INSERTI ISOLANTI E ZOCCOLI

INSULATING INSERTS AND GROMMETS

Elenco per quantità totale di contatti

List by contacts total quantity

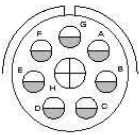
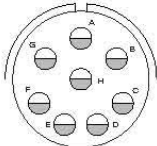
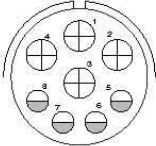
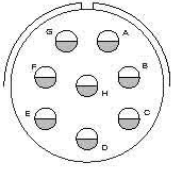
8 contatti 8 contacts				
	18-8	20-7	20B-8	22-18
DISPOSIZIONE INSERTO <i>ARRANGEMENT</i>				
NUMERO CONTATTI <i>NO. OF CONTACTS</i>	8	8	8	8
MISURA CONTATTO <i>CONTACT SIZE</i>	1-12, 7-16	8-16	4-12, 4-16	8-16
CODICE SERVIZIO <i>SERVICE RATING</i>	A	A,B,H,G=D - Bal.=A	*	A,B,F,G,H=D - Bal.=A

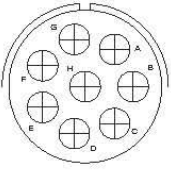
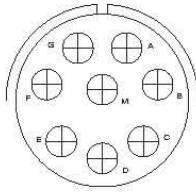
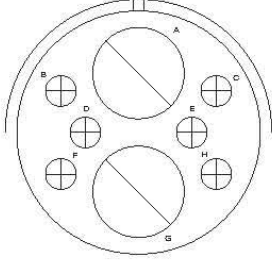
			
DISPOSIZIONE INSERTO <i>ARRANGEMENT</i>	22-23	24-6	32-15
NUMERO CONTATTI <i>NO. OF CONTACTS</i>	8	8	8
MISURA CONTATTO <i>CONTACT SIZE</i>	8-12	8-12	2-0, 6-12
CODICE SERVIZIO <i>SERVICE RATING</i>	H=D - Bal.=A	A,G,H=D - Bal.=A	D

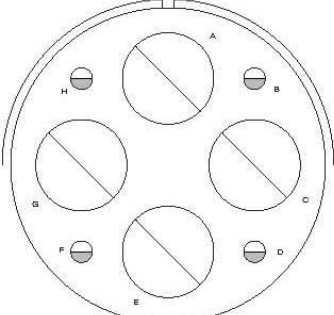
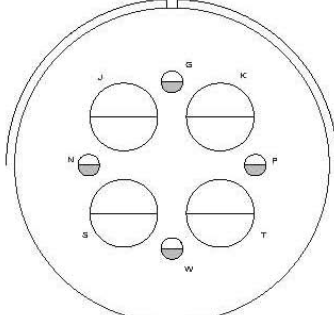
		
DISPOSIZIONE INSERTO <i>ARRANGEMENT</i>	40A-8	40A-10
NUMERO CONTATTI <i>NO. OF CONTACTS</i>	8	8
MISURA CONTATTO <i>CONTACT SIZE</i>	4-0, 4-16	4-4, 4-16
CODICE SERVIZIO <i>SERVICE RATING</i>	E	D

Vista frontale inserto contatti maschi

Front view male contacts insert



Legenda contatti

20

18

16



12

8

4

0

Contacts legend

	DISPOSIZIONE CONTATTI	
	CONTACTS LAYOUT	

INSERTI ISOLANTI E ZOCCOLI

Elenco per quantità totale di contatti

INSULATING INSERTS AND GROMMETS

List by contacts total quantity

9 contatti
9 contacts

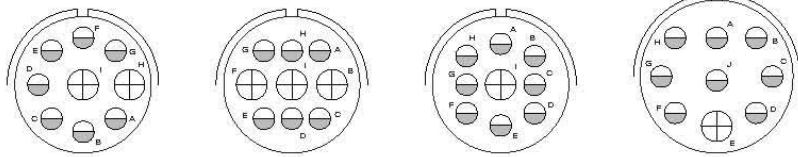

DISPOSIZIONE INSERTO <i>ARRANGEMENT</i>	20-16	20-18	20-21	22-17
NUMERO CONTATTI <i>NO. OF CONTACTS</i>	9	9	9	9
MISURA CONTATTO <i>CONTACT SIZE</i>	2-12, 7-16	3-12, 6-16	1-12, 8-16	1-12, 8-16
CODICE SERVIZIO <i>SERVICE RATING</i>	A	A	A	A=D - Bal.=I

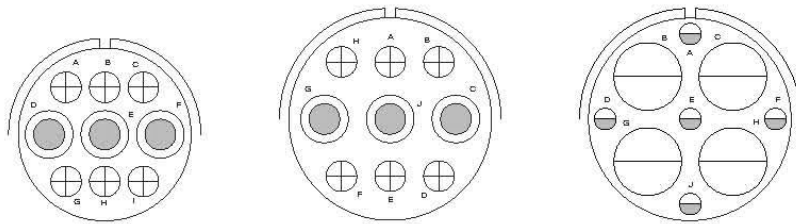

DISPOSIZIONE INSERTO <i>ARRANGEMENT</i>	24-11	28-1	28A-9
NUMERO CONTATTI <i>NO. OF CONTACTS</i>	9	9	9
MISURA CONTATTO <i>CONTACT SIZE</i>	3-8, 6-12	3-8, 6-12	4-4, 5-16
CODICE SERVIZIO <i>SERVICE RATING</i>	A	A, J, E=D - Bal.=A	A

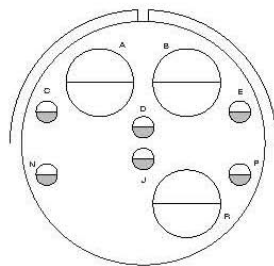

DISPOSIZIONE INSERTO <i>ARRANGEMENT</i>	32A-9
NUMERO CONTATTI <i>NO. OF CONTACTS</i>	9
MISURA CONTATTO <i>CONTACT SIZE</i>	3-4, 6-16
CODICE SERVIZIO <i>SERVICE RATING</i>	A

Vista frontale inserto contatti maschi



Front view male contacts insert



Legenda contatti

20 18 16 12 8 4 0

Contacts legend

	DISPOSIZIONE CONTATTI	
	CONTACTS LAYOUT	

INSERTI ISOLANTI E ZOCCOLI

INSULATING INSERTS AND GROMMETS

Elenco per quantità totale di contatti

List by contacts total quantity

10 contatti
10 contacts

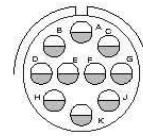
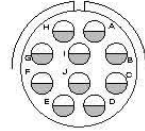
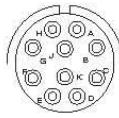

DISPOSIZIONE INSERTO <i>ARRANGEMENT</i>	16A-10	18-1	18-19
NUMERO CONTATTI <i>NO. OF CONTACTS</i>	10	10	10
MISURA CONTATTO <i>CONTACT SIZE</i>	10-18	10-16	10-16
CODICE SERVIZIO <i>SERVICE RATING</i>	A	B,C,F,G=A - Bal.=I	A

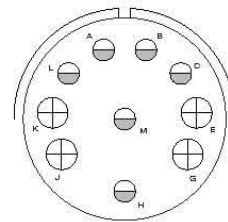
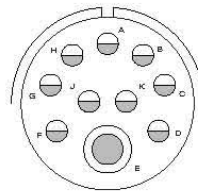
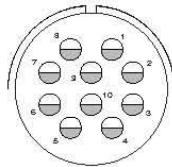

DISPOSIZIONE INSERTO <i>ARRANGEMENT</i>	22A-10	24-21	28-19
NUMERO CONTATTI <i>NO. OF CONTACTS</i>	10	10	10
MISURA CONTATTO <i>CONTACT SIZE</i>	10-16	9-16, 1-8	6-16, 4-12
CODICE SERVIZIO <i>SERVICE RATING</i>	A	D	H,M=B - A,B=D Bal.=A

11 contatti
11 contacts

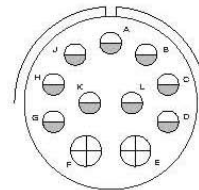
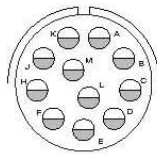

DISPOSIZIONE INSERTO <i>ARRANGEMENT</i>	20-33	24-20
NUMERO CONTATTI <i>NO. OF CONTACTS</i>	11	11
MISURA CONTATTO <i>CONTACT SIZE</i>	11-16	2-12, 9-16
CODICE SERVIZIO <i>SERVICE RATING</i>	A	D

Vista frontale inserto contatti maschi

Front view male contacts insert

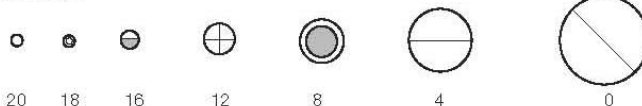

Legenda contatti

20

18

16

12

8

4

0

Contacts legend



DISPOSIZIONE CONTATTI



CONTACTS LAYOUT

INSERTI ISOLANTI E ZOCCOLI

INSULATING INSERTS AND GROMMETS

Elenco per quantità totale di contatti

List by contacts total quantity

12 contatti
12 contacts

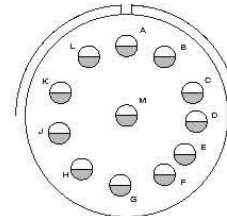
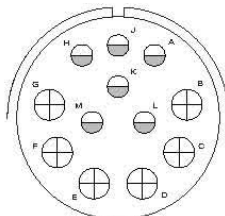
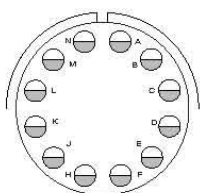

DISPOSIZIONE INSERTO
ARRANGEMENT

24-19

28-9

28-18

NUMERO CONTATTI
NO. OF CONTACTS

12

12

12

MISURA CONTATTO
CONTACT SIZE

12-16

6-12, 6-16

12-16

CODICE SERVIZIO
SERVICE RATING

A

D

M=C - A,B=A - G,H,J,K,L=D - Bal.=I

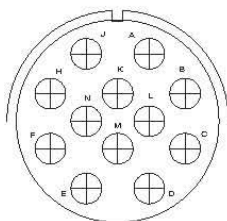

DISPOSIZIONE INSERTO
ARRANGEMENT

28-51

NUMERO CONTATTI
NO. OF CONTACTS

12

MISURA CONTATTO
CONTACT SIZE

12-12

CODICE SERVIZIO
SERVICE RATING

D

13 contatti
13 contacts

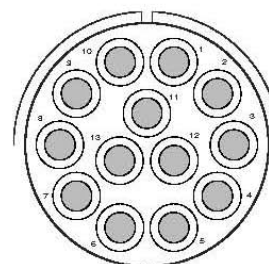
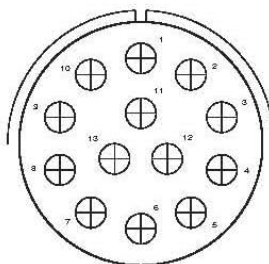
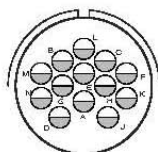

DISPOSIZIONE INSERTO
ARRANGEMENT

20-11

32A-13

32B-13

NUMERO CONTATTI
NO. OF CONTACTS

13

13

13

MISURA CONTATTO
CONTACT SIZE

13-16

13-12

13-8

CODICE SERVIZIO
SERVICE RATING

I

D

(*)

☐ Consultare l'Ufficio Vendite

☐ Consult our Sales Office

Vista frontale inserto contatti maschi

Front view male contacts insert



Legenda contatti

20

18

16



12

8

4

0

Contacts legend

	DISPOSIZIONE CONTATTI	
	CONTACTS LAYOUT	

INSERTI ISOLANTI E ZOCCOLI

INSULATING INSERTS AND GROMMETS

Elenco per quantità totale di contatti

List by contacts total quantity

14 contatti
14 contacts

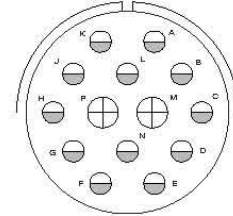
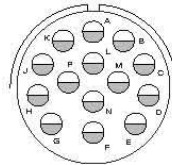
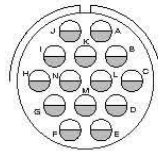

DISPOSIZIONE INSERTO <i>ARRANGEMENT</i>	20-27	22-19	28-2
NUMERO CONTATTI <i>NO. OF CONTACTS</i>	14	14	14
MISURA CONTATTO <i>CONTACT SIZE</i>	14-16	14-16	2-12, 12-16
CODICE SERVIZIO <i>SERVICE RATING</i>	A	A	D

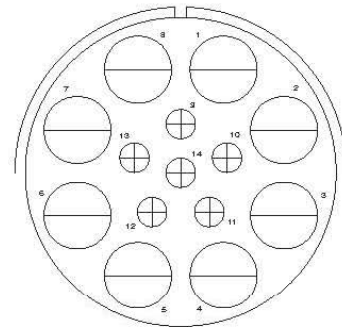
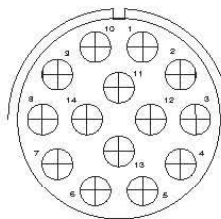
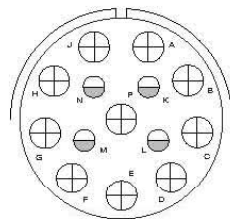

DISPOSIZIONE INSERTO <i>ARRANGEMENT</i>	28-20	28A-14	40A-14
NUMERO CONTATTI <i>NO. OF CONTACTS</i>	14	14	14
MISURA CONTATTO <i>CONTACT SIZE</i>	10-12, 4-16	14-12	8-4, 6-12
CODICE SERVIZIO <i>SERVICE RATING</i>	A	D	A

15 contatti
15 contacts

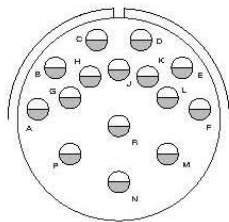

DISPOSIZIONE INSERTO <i>ARRANGEMENT</i>	28-17
NUMERO CONTATTI <i>NO. OF CONTACTS</i>	15
MISURA CONTATTO <i>CONTACT SIZE</i>	15-16
CODICE SERVIZIO <i>SERVICE RATING</i>	M,N,P=D - R=B - Bal=A

Vista frontale inserto contatti maschi

Front view male contacts insert

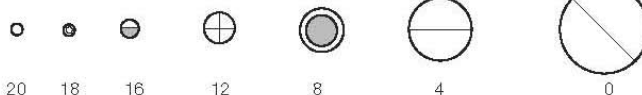

Legenda contatti

20

18

16



12

8

4

0

Contacts legend

	DISPOSIZIONE CONTATTI	
	CONTACTS LAYOUT	

INSERTI ISOLANTI E ZOCCOLI

Elenco per quantità totale di contatti

INSULATING INSERTS AND GROMMETS

List by contacts total quantity

16 contatti
16 contacts

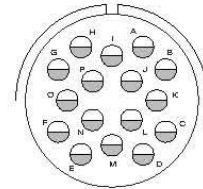
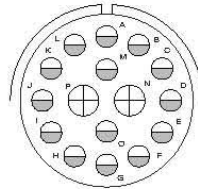
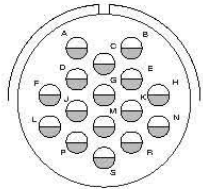

DISPOSIZIONE INSERTO <i>ARRANGEMENT</i>	24-5	24-7	24A-16
NUMERO CONTATTI <i>NO. OF CONTACTS</i>	16	16	16
MISURA CONTATTO <i>CONTACT SIZE</i>	16-16	2-12, 14-16	16-16
CODICE SERVIZIO <i>SERVICE RATING</i>	A	A	(*)

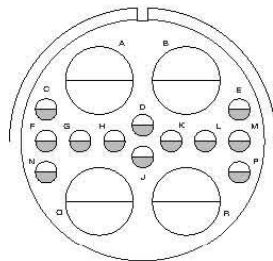

DISPOSIZIONE INSERTO <i>ARRANGEMENT</i>	32-68
NUMERO CONTATTI <i>NO. OF CONTACTS</i>	16
MISURA CONTATTO <i>CONTACT SIZE</i>	4-4, 12-16
CODICE SERVIZIO <i>SERVICE RATING</i>	A

17 contatti
17 contacts

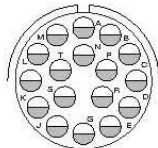

DISPOSIZIONE INSERTO <i>ARRANGEMENT</i>	20-29
NUMERO CONTATTI <i>NO. OF CONTACTS</i>	17
MISURA CONTATTO <i>CONTACT SIZE</i>	17-16
CODICE SERVIZIO <i>SERVICE RATING</i>	A

☐ Consultare l'Ufficio Vendite

☐ Consult our Sales Office

Vista frontale inserto contatti maschi



Front view male contacts insert



Legenda contatti

20 18 16 12 8 4 0

Contacts legend

	DISPOSIZIONE CONTATTI	
	CONTACTS LAYOUT	

INSERTI ISOLANTI E ZOCCOLI

INSULATING INSERTS AND GROMMETS

Elenco per quantità totale di contatti

List by contacts total quantity

19 contatti
19 contacts

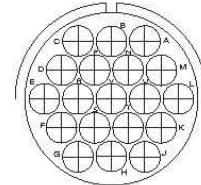
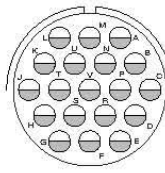
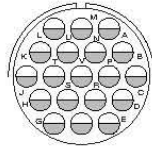

DISPOSIZIONE INSERTO <i>ARRANGEMENT</i>	20A-48	22-14	24-67
NUMERO CONTATTI <i>NO. OF CONTACTS</i>	19	19	19
MISURA CONTATTO <i>CONTACT SIZE</i>	19-16	19-16	19-12
CODICE SERVIZIO <i>SERVICE RATING</i>	I	A	A

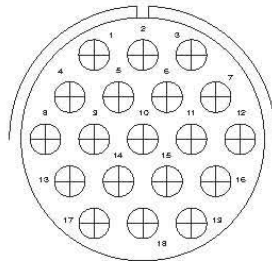

DISPOSIZIONE INSERTO <i>ARRANGEMENT</i>	32-76
NUMERO CONTATTI <i>NO. OF CONTACTS</i>	19
MISURA CONTATTO <i>CONTACT SIZE</i>	19-12
CODICE SERVIZIO <i>SERVICE RATING</i>	A

20 contatti
20 contacts

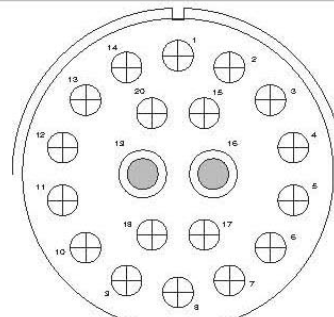
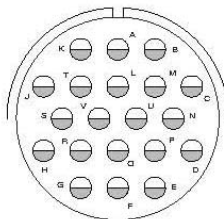

DISPOSIZIONE INSERTO <i>ARRANGEMENT</i>	28-16	40A-20
NUMERO CONTATTI <i>NO. OF CONTACTS</i>	20	20
MISURA CONTATTO <i>CONTACT SIZE</i>	20-16	2-8, 18-12
CODICE SERVIZIO <i>SERVICE RATING</i>	A	A

Vista frontale inserto contatti maschi



Front view male contacts insert



Legenda contatti

20 18 16 12 8 4 0

Contacts legend

	DISPOSIZIONE CONTATTI	
	CONTACTS LAYOUT	

INSERTI ISOLANTI E ZOCCOLI

Elenco per quantità totale di contatti

INSULATING INSERTS AND GROMMETS

List by contacts total quantity

22 contatti
22 contacts

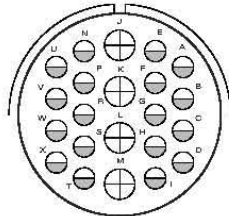

28-11

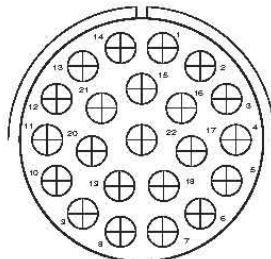

32A-22

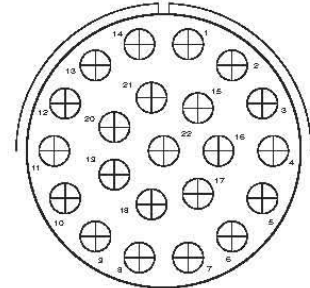

36A-22

DISPOSIZIONE INSERTO
ARRANGEMENT

NUMERO CONTATTI
NO. OF CONTACTS

MISURA CONTATTO
CONTACT SIZE

CODICE SERVIZIO
SERVICE RATING

22

22

22

4-12, 18-16

22-12

22-12

A

(*)

D

23 contatti
23 contacts

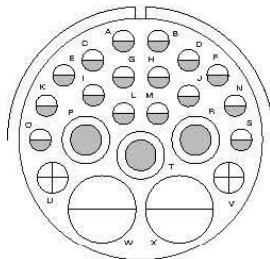

32-6

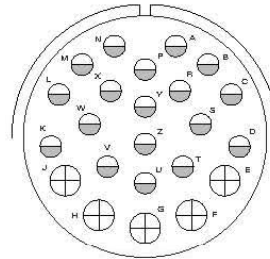

32-13

DISPOSIZIONE INSERTO
ARRANGEMENT

NUMERO CONTATTI
NO. OF CONTACTS

MISURA CONTATTO
CONTACT SIZE

CODICE SERVIZIO
SERVICE RATING

23

23

2-4, 3-8, 2-12, 16-16

5-12, 18-16

A

D

24 contatti
24 contacts

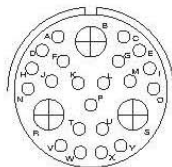

22A-24

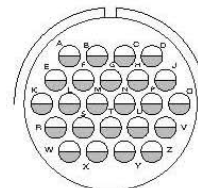

24-28

DISPOSIZIONE INSERTO
ARRANGEMENT

NUMERO CONTATTI
NO. OF CONTACTS

MISURA CONTATTO
CONTACT SIZE

CODICE SERVIZIO
SERVICE RATING

24

24

3-12, 21-20

24-16

(*)

I

☐ Consultare l'Ufficio Vendite

☐ Consult our Sales Office

Vista frontale inserto contatti maschi

Front view male contacts insert



Legenda contatti

20 18 16 12 8 4 0

Contacts legend



DISPOSIZIONE CONTATTI



CONTACTS LAYOUT

INSERTI ISOLANTI E ZOCCOLI

INSULATING INSERTS AND GROMMETS

Elenco per quantità totale di contatti

List by contacts total quantity

25 contatti
25 contacts

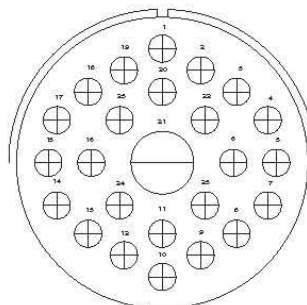
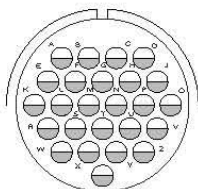

DISPOSIZIONE INSERTO
ARRANGEMENT

24A-25

40A-25

NUMERO CONTATTI
NO. OF CONTACTS

25

25

MISURA CONTATTO
CONTACT SIZE

25-16

1-4, 24-12

CODICE SERVIZIO
SERVICE RATING

I

A

26 contatti
26 contacts

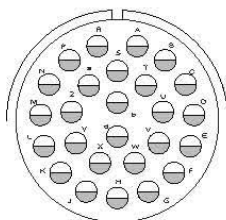

28 contatti
28 contacts

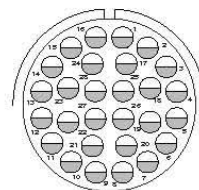

DISPOSIZIONE INSERTO
ARRANGEMENT

28-12

24A-28

NUMERO CONTATTI
NO. OF CONTACTS

26

28

MISURA CONTATTO
CONTACT SIZE

26-16

28-16

CODICE SERVIZIO
SERVICE RATING

A

I

29 contatti
29 contacts

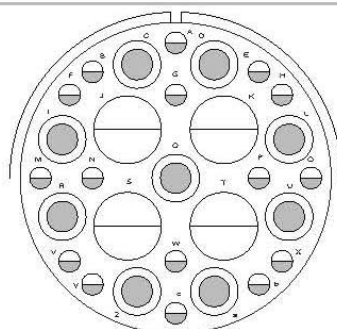

30 contatti
30 contacts

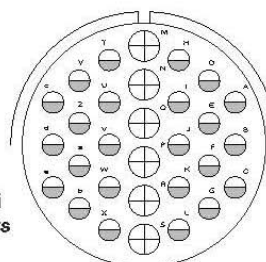

DISPOSIZIONE INSERTO
ARRANGEMENT

40-10

32-8

NUMERO CONTATTI
NO. OF CONTACTS

29

30

MISURA CONTATTO
CONTACT SIZE

4-4, 9-8, 16-16

6-12, 24-16

CODICE SERVIZIO
SERVICE RATING

A

A

Vista frontale inserto contatti maschi

Front view male contacts insert



Legenda contatti

20

18

16



12

8

4

0

Contacts legend

	DISPOSIZIONE CONTATTI	
	CONTACTS LAYOUT	

INSERTI ISOLANTI E ZOCCOLI

INSULATING INSERTS AND GROMMETS

Elenco per quantità totale di contatti

List by contacts total quantity

30 contatti
30 contacts

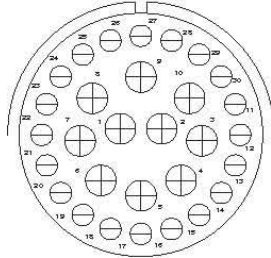

DISPOSIZIONE INSERTO <i>ARRANGEMENT</i>	32A-30
NUMERO CONTATTI <i>NO. OF CONTACTS</i>	30
MISURA CONTATTO <i>CONTACT SIZE</i>	10-12, 20-16
CODICE SERVIZIO <i>SERVICE RATING</i>	A

31 contatti
31 contacts

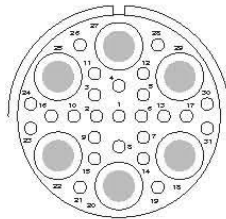

DISPOSIZIONE INSERTO <i>ARRANGEMENT</i>	28A-31
NUMERO CONTATTI <i>NO. OF CONTACTS</i>	31
MISURA CONTATTO <i>CONTACT SIZE</i>	25-20, 6-8
CODICE SERVIZIO <i>SERVICE RATING</i>	(*)

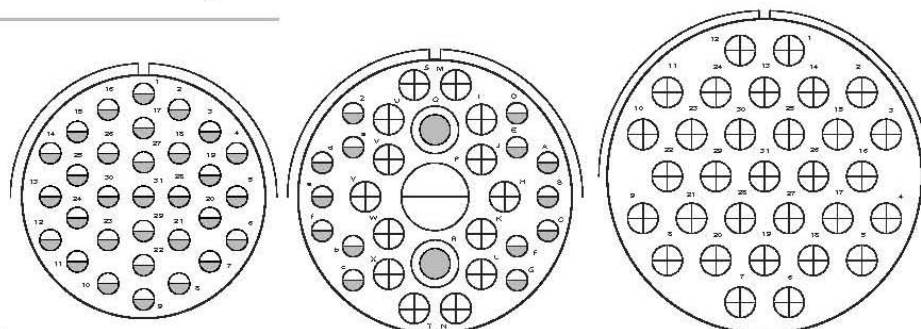

DISPOSIZIONE INSERTO <i>ARRANGEMENT</i>	32-31	36-9	40A-31
NUMERO CONTATTI <i>NO. OF CONTACTS</i>	31	31	31
MISURA CONTATTO <i>CONTACT SIZE</i>	31-16	1-4, 2-8, 14-12, 14-16	31-12
CODICE SERVIZIO <i>SERVICE RATING</i>	A	A	D

☐ Consultare l'Ufficio Vendite
Vista frontale inserto contatti maschi

☐ Consult our Sales Office
Front view male contacts insert

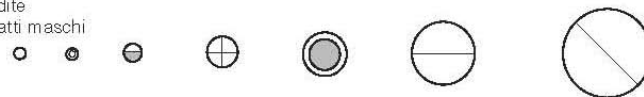

Legenda contatti

20 18 16 12 8 4 0

Contacts legend

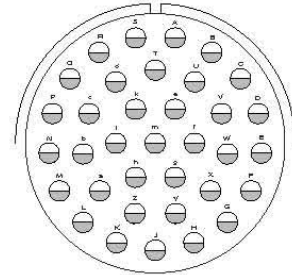
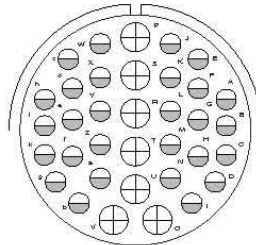
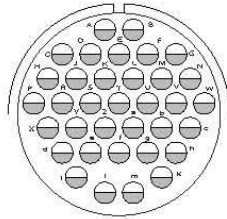
**DISPOSIZIONE CONTATTI****CONTACTS LAYOUT****INSERTI ISOLANTI E ZOCCOLI****Elenco per quantità totale di contatti****INSULATING INSERTS AND GROMMETS****List by contacts total quantity****35 contatti**
35 contacts**DISPOSIZIONE INSERTO**
ARRANGEMENT

28-15

32-7

36-15

NUMERO CONTATTI
NO. OF CONTACTS

35

35

35

MISURA CONTATTO
CONTACT SIZE

35-16

7-12, 28-16

35-16

CODICE SERVIZIO
SERVICE RATING

A

A,B,h,j=l - Bal.=A

M=D - Bal.=A

DISPOSIZIONE INSERTO
ARRANGEMENT

40A-35

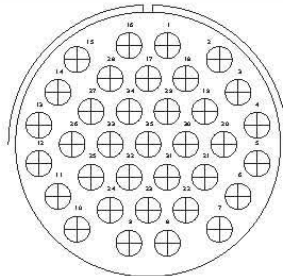
**NUMERO CONTATTI**
NO. OF CONTACTS

35

MISURA CONTATTO
CONTACT SIZE

35-12

CODICE SERVIZIO
SERVICE RATING

D

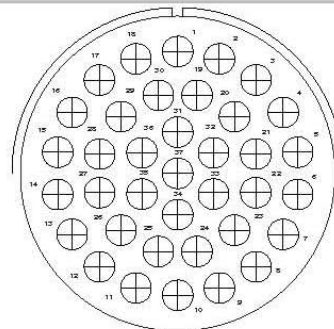
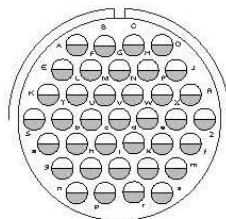
37 contatti
37 contacts**DISPOSIZIONE INSERTO**
ARRANGEMENT

28-21

40B-37

NUMERO CONTATTI
NO. OF CONTACTS

37

37

MISURA CONTATTO
CONTACT SIZE

37-16

37-12

CODICE SERVIZIO
SERVICE RATING

A

A

Vista frontale inserto contatti maschi

Front view male contacts insert

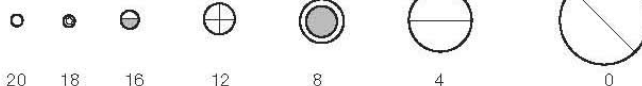

Legenda contatti

20

18

16

12

8

4

0

Contacts legend



DISPOSIZIONE CONTATTI



CONTACTS LAYOUT

INSERTI ISOLANTI E ZOCCOLI

INSULATING INSERTS AND GROMMETS

Elenco per quantità totale di contatti

List by contacts total quantity

42 contatti
42 contacts

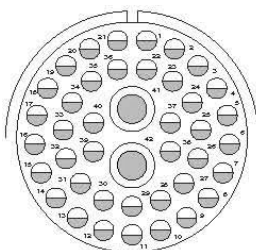

47 contatti
47 contacts

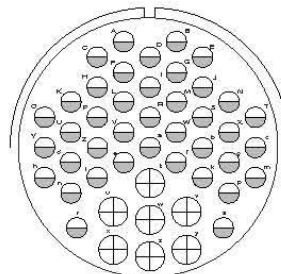

DISPOSIZIONE INSERTO
ARRANGEMENT

32-59

36-7

NUMERO CONTATTI
NO. OF CONTACTS

42

47

MISURA CONTATTO
CONTACT SIZE

2-8, 40-16

7-12, 40-16

CODICE SERVIZIO
SERVICE RATING

A

A

47 contatti
47 contacts

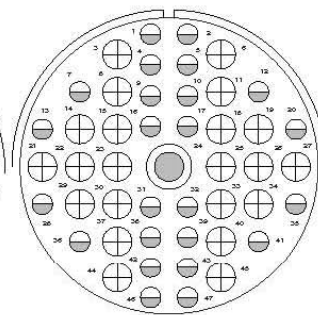
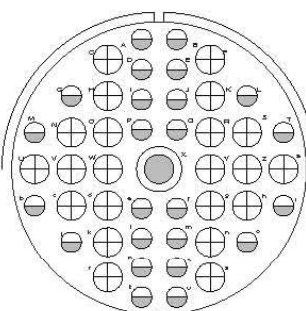
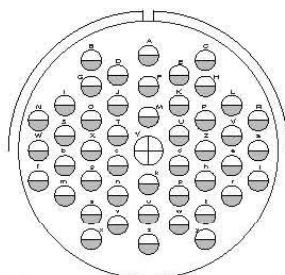

DISPOSIZIONE INSERTO
ARRANGEMENT

36-8

40-9

40A-47

NUMERO CONTATTI
NO. OF CONTACTS

47

47

47

MISURA CONTATTO
CONTACT SIZE

1-12, 46-16

1-8, 22-12, 24-16

1-8, 22-12, 24-16

CODICE SERVIZIO
SERVICE RATING

A

A

A

48 contatti
48 contacts

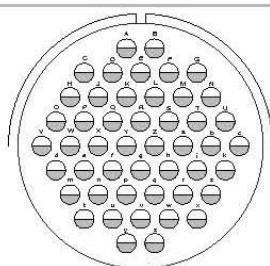

54 contatti
54 contacts

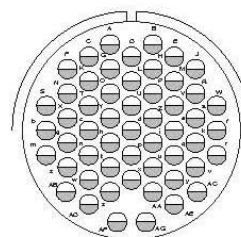

DISPOSIZIONE INSERTO
ARRANGEMENT

36-10

32-22

NUMERO CONTATTI
NO. OF CONTACTS

48

54

MISURA CONTATTO
CONTACT SIZE

48-16

54-16

CODICE SERVIZIO
SERVICE RATING

A

A

Vista frontale inserto contatti maschi

Front view male contacts insert



Legenda contatti

20

18

16

12

8

4

0

Contacts legend



DISPOSIZIONE CONTATTI



CONTACTS LAYOUT

INSERTI ISOLANTI E ZOCCOLI

INSULATING INSERTS AND GROMMETS

Elenco per quantità totale di contatti

List by contacts total quantity

55 contatti
55 contacts

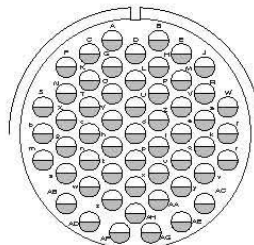
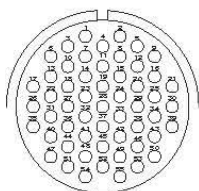

DISPOSIZIONE INSERTO
ARRANGEMENT

24A-55

32A-55

NUMERO CONTATTI
NO. OF CONTACTS

55

55

MISURA CONTATTO
CONTACT SIZE

55-20

55-16

CODICE SERVIZIO
SERVICE RATING

I

A

60 contatti
60 contacts

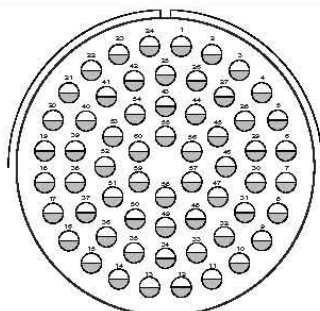

61 contatti
61 contacts

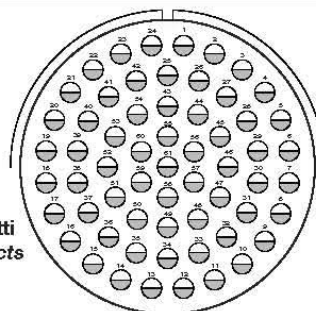

DISPOSIZIONE INSERTO
ARRANGEMENT

40A-60

40-63

NUMERO CONTATTI
NO. OF CONTACTS

60

61

MISURA CONTATTO
CONTACT SIZE

60-16

61-16

CODICE SERVIZIO
SERVICE RATING

A

A

62 contatti
62 contacts

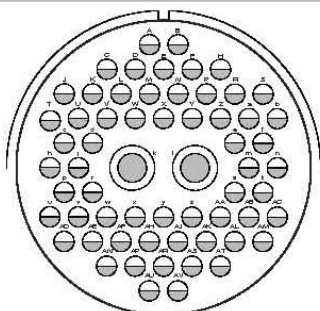

72 contatti
72 contacts

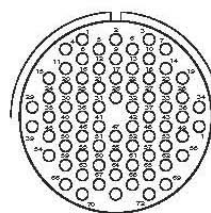

DISPOSIZIONE INSERTO
ARRANGEMENT

40A-62

28-72

NUMERO CONTATTI
NO. OF CONTACTS

62

72

MISURA CONTATTO
CONTACT SIZE

2-8, 60-16

72-20

CODICE SERVIZIO
SERVICE RATING

A

I

Vista frontale inserto contatti maschi

Front view male contacts insert



Legenda contatti

20

18

16

12

8

4

0

Contacts legend



DISPOSIZIONE CONTATTI



CONTACTS LAYOUT

INSERTI ISOLANTI E ZOCCOLI

INSULATING INSERTS AND GROMMETS

Elenco per quantità totale di contatti

List by contacts total quantity

85 contatti
85 contacts

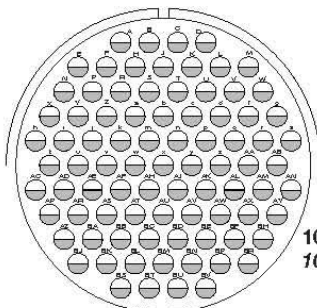

100 contatti
100 contacts

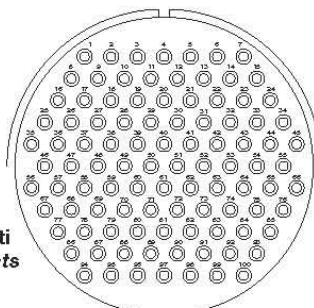

DISPOSIZIONE INSERTO
ARRANGEMENT

40-56

40A-100

NUMERO CONTATTI
NO. OF CONTACTS

85

100

MISURA CONTATTO
CONTACT SIZE

85-16

100-18

CODICE SERVIZIO
SERVICE RATING

A

A

101 contatti
101 contacts

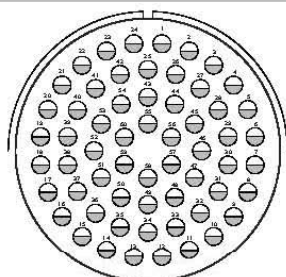

DISPOSIZIONE INSERTO
ARRANGEMENT

32A-101

NUMERO CONTATTI
NO. OF CONTACTS

101

MISURA CONTATTO
CONTACT SIZE

20

CODICE SERVIZIO
SERVICE RATING

I

150 contatti
150 contacts

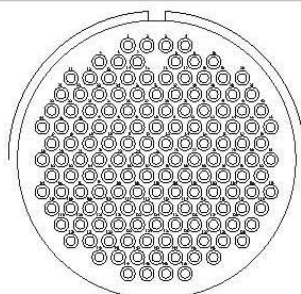

201 contatti
201 contacts

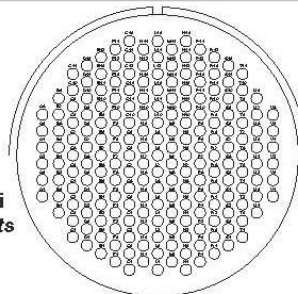

DISPOSIZIONE INSERTO
ARRANGEMENT

40A-150

40A-201

NUMERO CONTATTI
NO. OF CONTACTS

150

201

MISURA CONTATTO
CONTACT SIZE

150-18

201-20

CODICE SERVIZIO
SERVICE RATING

I

(*)

☉ Consultare l'Ufficio Vendite
Vista frontale inserto contatti maschi

☉ Consult our Sales Office
Front view male contacts insert



Legenda contatti

20

18

16

12

8

4

0

Contacts legend