

Control stations P, I and A



Ex e

The control and monitoring units of series P, I and A... are manufactured from fibreglass reinforced polyester, stainless steel or aluminium, and are suitable for housing electrical command and signal devices. **The units are preconfigured according to the following diagrams and can be ordered using their respective product code.** They can be installed both on board the machine or remotely, and are used in the chemical, petrochemical and pharmaceutical industries. In addition to the following listed standards, manufacturer offers a wide range of accessories and versions manufactured to customer specification.

Manufacturer applies a tamper-evident holographic security label to its products, complete with a unique authentication numeric code, to combat the illegal sale of imitations and counterfeits, as well as guarantee the authenticity of its products. The failure to observe international standards involves serious hazards to the environment and, above all, personnel who work with the systems on a daily basis.

Sectors of application:



Petroleum refineries



Chemical and petrochemical plants



Onshore plants



Offshore plants



Petroleum loading/unloading pontoons



Low temperatures



Mining operations

CERTIFICATION DATA

Classification:

Group II

Category 2GD

Installation: EN 60079.14

zone 1 - zone 2 (Gas)

zone 21 - zone 22 (Dust)

Marking:

CE 0722 Ex II 2 GD; Ex de IIC T6, T5 Gb; Ex tb IIIC T85°C Db

Certificate:

ATEX CESI 03 ATEX 115

IECEX IECEX CES 11.0032

TR CU AVAILABLE

For all IEC Ex and TR CU certification data, contact comm@antideflagrante.com

Standards:

CENELEC EN 60079-0: 2012, EN 60079-1: 2007, EN 60079-7: 2007, EN 60079-31: 2009 and EUROPEAN DIRECTIVE 2014/34/UE
RoHS Directive 2002/95/EC.

Temperature class:

T6 (Ta +40°C)

T5 (Ta +55°C)

Ambient Temp.:

-40 °C +55 °C

-40°C +40°C

Degree of protection:

IP66



Control station type P (reinforced polyester)

Ex e



EXPLODED VIEW

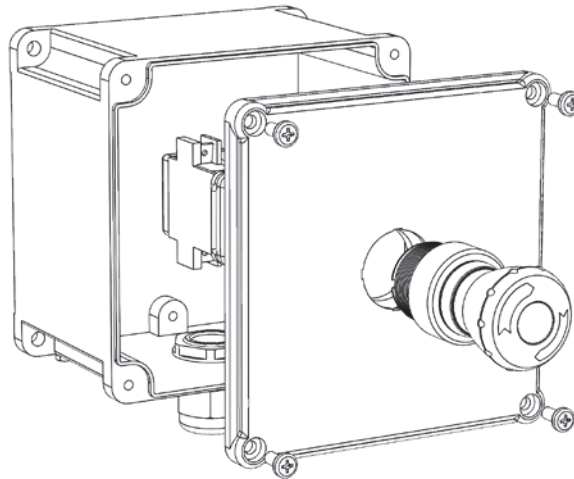

MECHANICAL FEATURES

Body and cover:	Black antistatic fibreglass reinforced polyester complete with fixing lugs
Gaskets:	Acid, hydrocarbon and high temperature resistant silicon positioned between the body and the cover
Certificate plate:	Riveted aluminium
Screws:	Stainless steel
Earth screw:	Internal M5 on body and cover connected to each other with a 2.5 mm wire ²
Cable gland:	Polyamide type UNI1LXE7

ACCESSORIES UPON REQUEST / SPECIAL REQUESTS





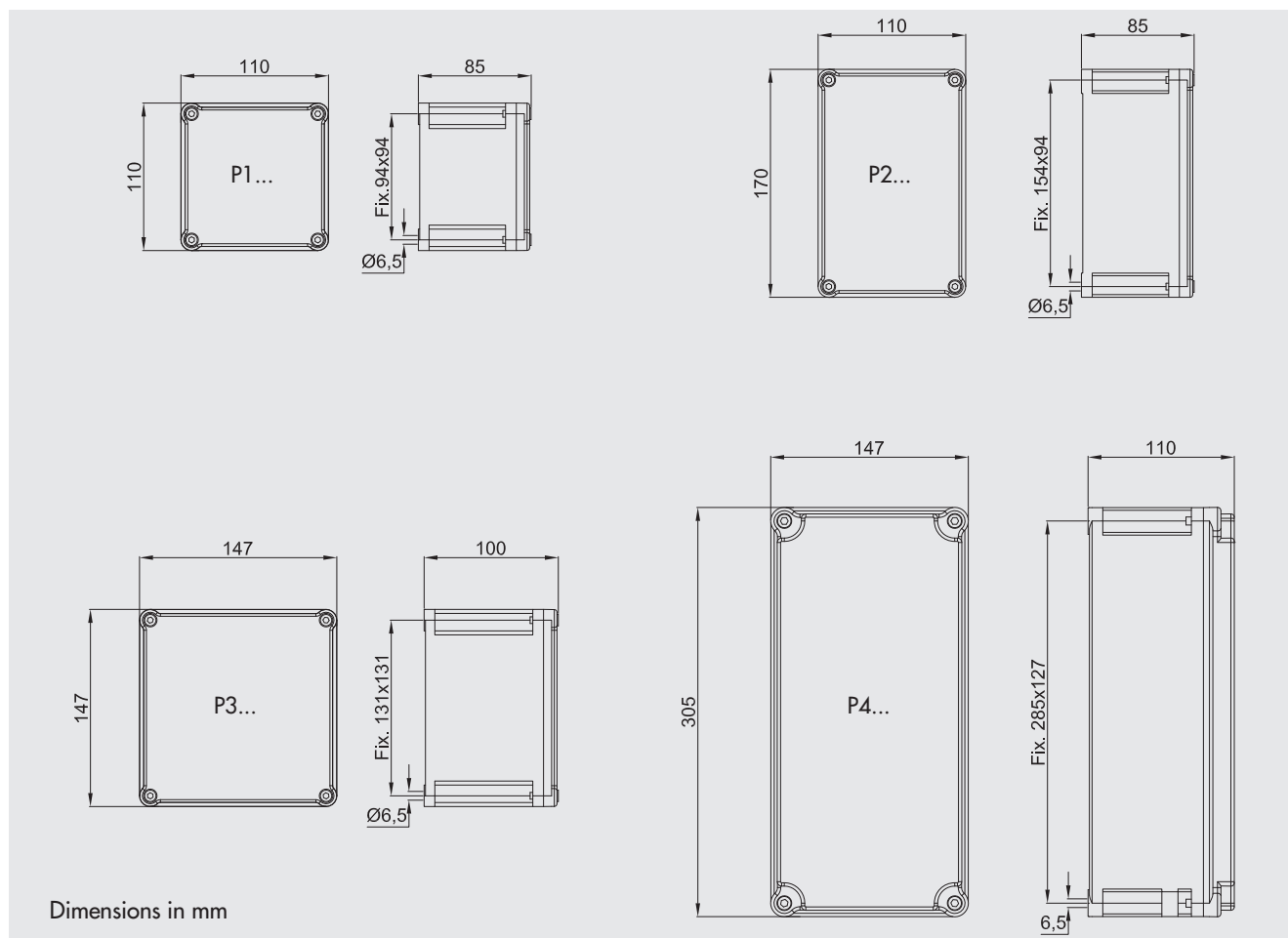

- Safety measures and padlocks for stations
- Safety measures against accidental contacts (padlockable)
- Earthing rings for control units
- Nameplates in various materials
- Breather or drainage valve
- Metal cable glands
- Other contact types (see Ex e Control, monitoring and signalling stations folder)
- Various possible configurations

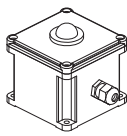

DIMENSIONAL DIAGRAM

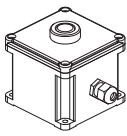
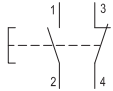

CODE SELECTION TABLE

Illustration	Description	Diagram	Codes
	One red 24 VAC/DC indicator light		P1T01R9
	One green 24 VAC/DC indicator light		P1T01V9
	One blue 24 VAC/DC indicator light		P1T01B9
	One yellow 24 VAC/DC indicator light		P1T01G9
	One colourless 24 VAC/DC indicator light		P1T01I9
	One red 1NO+1NC pushbutton		P1T01R3
	One black 1NO+1NC pushbutton		P1T01N3
	One green 1NO+1NC pushbutton		P1T01V3
	One red 1NO pushbutton		P1T01R1
	One black 1NO pushbutton		P1T01N1
	One green 1NO pushbutton		P1T01V1
	One red 1NC pushbutton		P1T01R2
	One black 1NC pushbutton		P1T01N2
	One green 1NC pushbutton		P1T01V2
	One red 2NO pushbutton		P1T01R4
	One black 2NO pushbutton		P1T01N4
	One green 2NO pushbutton		P1T01V4
	One red 2NC pushbutton		P1T01R5
	One black 2NC pushbutton		P1T01N5
	One green 2NC pushbutton		P1T01V5

Control station type P (reinforced polyester)













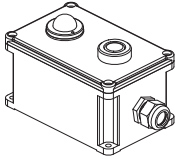

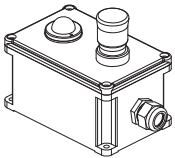
Ex e

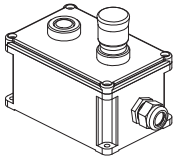
CODE SELECTION TABLE

Illustration	Description	Diagram	Codes
Selector			
	Switch with two fixed-positions, suitable for "automatic-manual" 1NO+1NC service		P1T011Z
	Motors "start-stop" control, with spring return to 0 from both STOP and START.		P1T011X
	Motors "start-stop" control with spring return from START to 0, and in fixed STOP position can be padlocked.		P1T011R
	Three fixed position switch can be padlocked in the centre position. Versions: single pole - double pole - triple pole.		P1T011C
	Button		
	Emergency mushroom head pushbutton with 1NO+1NC block (when pressed, rotate to release)		P1T01F3
	Emergency mushroom head pushbutton with 1NC block (when pressed, rotate to release)		P1T01F2
Ammeter/voltmeter			
	Ammeter (scale on request)		P1T02A
	Voltmeter (scale on request)		P1T02V
Two buttons			
	Red pushbutton + green pushbutton, 1NO+1NC contacts		P2T07R3V3
	Black pushbutton + green pushbutton, 1NO+1NC contacts		P2T07N3V3
	Red pushbutton + green pushbutton, 1NO contacts		P2T07R1V1
	Black pushbutton + green pushbutton, 1NO contacts		P2T07N1V1
Indicator light and pushbutton			
	24 VAC/DC red indicator light and one red 1NO+1NC pushbutton		P2T07R9R3
	24 VAC/DC green indicator light and one green 1NO+1NC pushbutton		P2T07V9V3
	24 VAC/DC red indicator light and one red 1NC pushbutton		P2T07R9R2
	24 VAC/DC green indicator light and one green 1NC pushbutton		P2T07V9V2

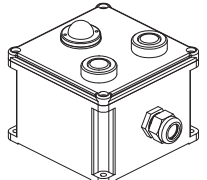

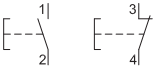
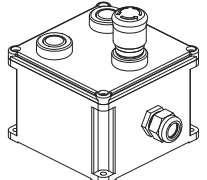
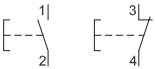
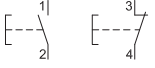
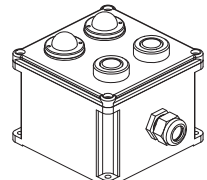
CODE SELECTION TABLE

Illustration	Description	Diagram	Codes
	24 VAC/DC red indicator light and one red 1NO pushbutton		P2T07R9R1
	24 VAC/DC green indicator light and one green 1NO pushbutton		P2T07V9V1
	24 VAC/DC red indicator light and emergency 1NO+1NC mushroom pushbutton		P2T07R9F3
	24 VAC/DC green indicator light and 1NO+1NC emergency mushroom pushbutton		P2T07V9F3
	Green 1NO pushbutton and one 1NO emergency mushroom head pushbutton		P2T07V1F1
	Yellow 1NO pushbutton and one 1NO emergency mushroom head pushbutton		P2T07G1F1
	Green 1NO+1NC pushbutton and one 1NO+1NC emergency mushroom head pushbutton		P2T07V3F3
	Yellow 1NO+1NC pushbutton and one 1NO+1NC emergency mushroom head pushbutton		P2T07G3F3
	24 VAC/DC green LED indicator light, one green 1NO pushbutton and red 1NC pushbutton		P3T18V9V1R2
			
	One green 1NO and one red 1NC pushbutton, one mushroom head 1NO pushbutton		P3T17V1R2F1
	One green 1NO and one red 1NC pushbutton, one mushroom head 1NC pushbutton		P3T17V1R2F2
	24 VAC/DC red and green LED indicator lights, one green 1NO pushbutton and red 1NC pushbutton		P3T19V9R9V1R2
			



Control station type P (reinforced polyester)

Ex e

CODE SELECTION TABLE

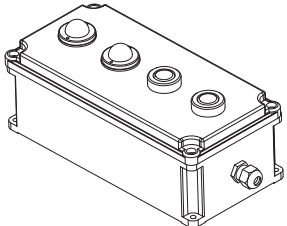
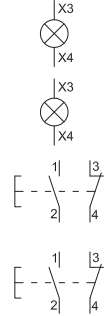
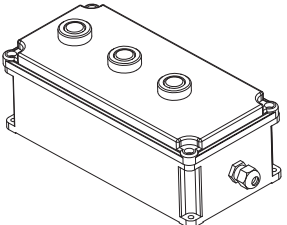
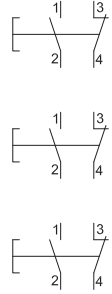
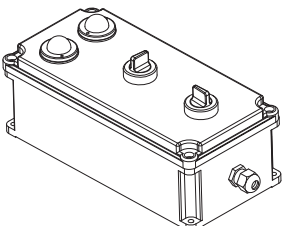
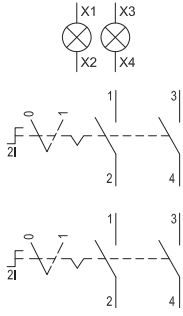
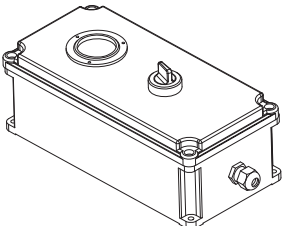
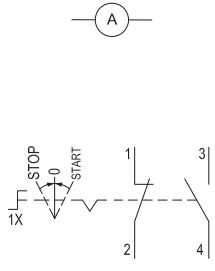
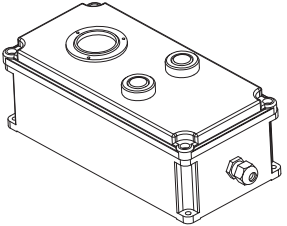
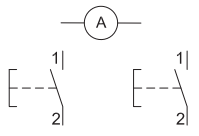
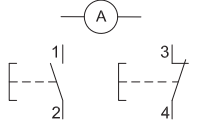
Illustration	Description	Diagram	Codes
<p>Two indicator lights and two pushbuttons</p> 	<p>24 VAC/DC red and green LED indicator lights, one green 1NO+1NC pushbutton and red 1NO+1NC pushbutton</p>		<p>P4T25V9R9V3R3</p>
<p>Three buttons</p> 	<p>Two green pushbuttons and one red 1NO+1NC</p>		<p>P4T26V3R3V3</p>
<p>Two indicator lights and two selectors</p> 	<p>24 VAC/DC red and green LED indicator lights, two switches arrangement 2I</p>		<p>P4T27R9V92I2I</p>
<p>Ammeter and selector</p> 	<p>Ammeter 1 A, scale 3 - 5 In and "start-stop" motors control switch, with spring return to 0 from both STOP and START.</p>		<p>P4T39A1X</p>
<p>Ammeter and two buttons</p> 	<p>Ammeter 1 A, scale 3 - 5 In with red 1NO pushbutton and green 1NO pushbutton</p>		<p>P4T40AR1V1</p>
	<p>Ammeter 1 A, scale 3 - 5 In with red 1NO pushbutton and green 1NC pushbutton</p>		<p>P4T40AR1V2</p>