



YFC Series explosion-proof limit switches feature an actuator linked mechanically to the contacts. The series includes both position switches and switches for safety applications. They are available in ten basic versions, depending on the type of actuator used, or sixty versions, if snap-action or slow-action contacts are considered.

Thanks to the combination of various types of actuators, bodies and contacts, YFC limit switches are ideal for a wide range of applications and for seamless system operation.

Being corrosion- and vibration-resistant, their mechanical and electrical components are able to withstand the extreme mechanical and thermal stresses they are continuously subjected to. Designed for installation in potentially explosive atmospheres, in the presence of combustible gases (hydrogen and acetylene), vapour, mist and powders, zones 1 and 21, 2 and 22, they are also used in watertight industrial and civil applications.

Manufacturer applies a tamper-evident holographic security label to its products, complete with a unique authentication numeric code, to combat the illegal sale of imitations and counterfeits, as well as guarantee the authenticity of its products. Failure to observe international standards creates serious risks for the environment and, above all, for the personnel who work with the systems on a daily basis.

Sectors of application:



Petroleum refineries



Chemical and petrochemical facilities



Onshore facilities



Offshore facilities



Petroleum loading/unloading pontoons



Agribusiness facilities



Fuel storage facilities

EMPTY ENCLOSURE CERTIFICATION DATA

Classification:	Group II	Category 2GD		
Installation: EN 60079.14	zone 1 - zone 2 (Gas)	zone 21 - zone 22 (Dust)		
Marking:	CE 0722 Ex II 2 GD Ex d IIC T6 Ex d tD A21 T85°C IP66/67			
Certificate:	ATEX	<u>SIRA 07 ATEX 1316</u>		
	IEC Ex	<u>IECEX SIR 07.0104</u>	For all IEC Ex and TR CU certification data, contact comm@antideflagrante.com	
	TR CU	<u>B.02204</u>		
Standard:	CENELEC EN 60079-0: 2006, EN 60079-1: 2004, EN 61241-0: 2006, EN 61241-1: 2004 and European Directive 2014/34/EU. IEC 60079-0: 2004, IEC 60079-1: 2003, IEC 61241-0: 2004, IEC 61241-1: 2004 RoHS Directive 2002/95/EC.			
Temperature class:	85°C (T6)			
Ambient Temp.:	-20°C +55°C			
Degree of protection:	IP66/67			



MECHANICAL FEATURES

Body:	Low copper content aluminium alloy, complete with wall fastening lugs
Gaskets:	Acid, hydrocarbon and high temperature resistant silicone positioned between the body and the cover
Certification label:	Adhesive affixed to external surface
Screws:	Stainless steel
Earth screw:	Internal and external stainless steel
Coating:	Polyester RAL 7035 (Light grey)
Entry points:	One entry point ISO M20x1.5
Mounting positions:	All positions
Consistency (measured following a million operations):	0.05 mm (at the point of closure)
Minimum control speed:	0.06 m/s slow action 0.001 m/s snap action

Corrosion Resistance:

The STANDARD of the aluminium alloy used by manufacturer has passed the tests required by standards EN60068-2-30 (hot-humid cycles) and EN60068-2-11 (salt fog test)

ELECTRICAL FEATURES

Rated voltage:	max. 500 Vac, 250 Vdc
Rated frequency:	max. 50/60 Hz
Rated current:	24 Vac - 50/60 Hz: 10 A 120 Vac - 50/60 Hz: 6 A 230 Vac - 50/60 Hz: 3.1 240 Vac - 50/60 Hz: 3.1 A 400 Vac - 50/60 Hz: 1.8 A 24 Vdc: 2.8 A 125 Vdc: 0.55 A 250 Vdc: 0.27 A
Connecting cable cross-section:	0.75 ... 2.5 mm ²

ACCESSORIES UPON REQUEST / SPECIAL REQUESTS

Cable gland



DIMENSIONAL DRAWING

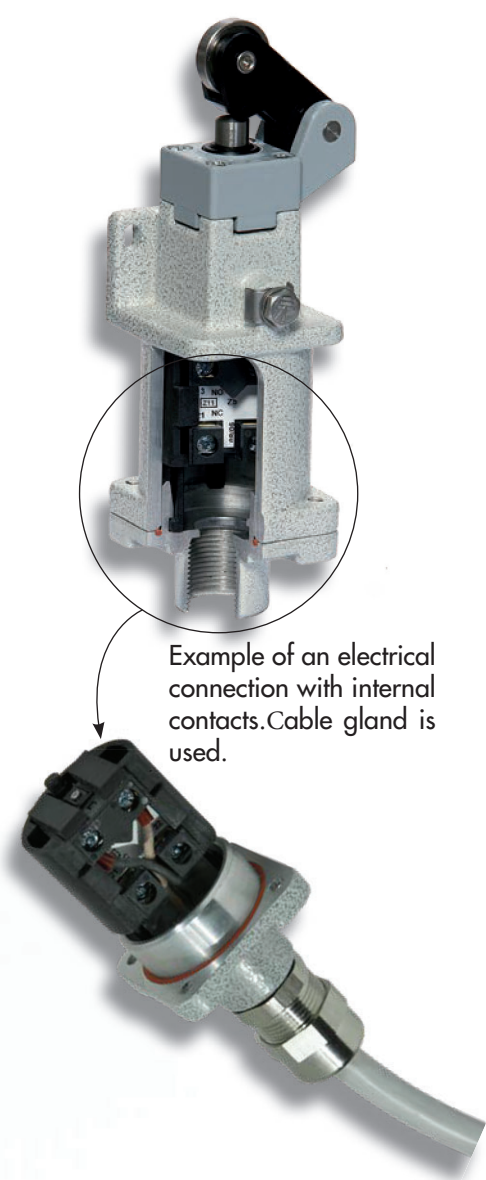
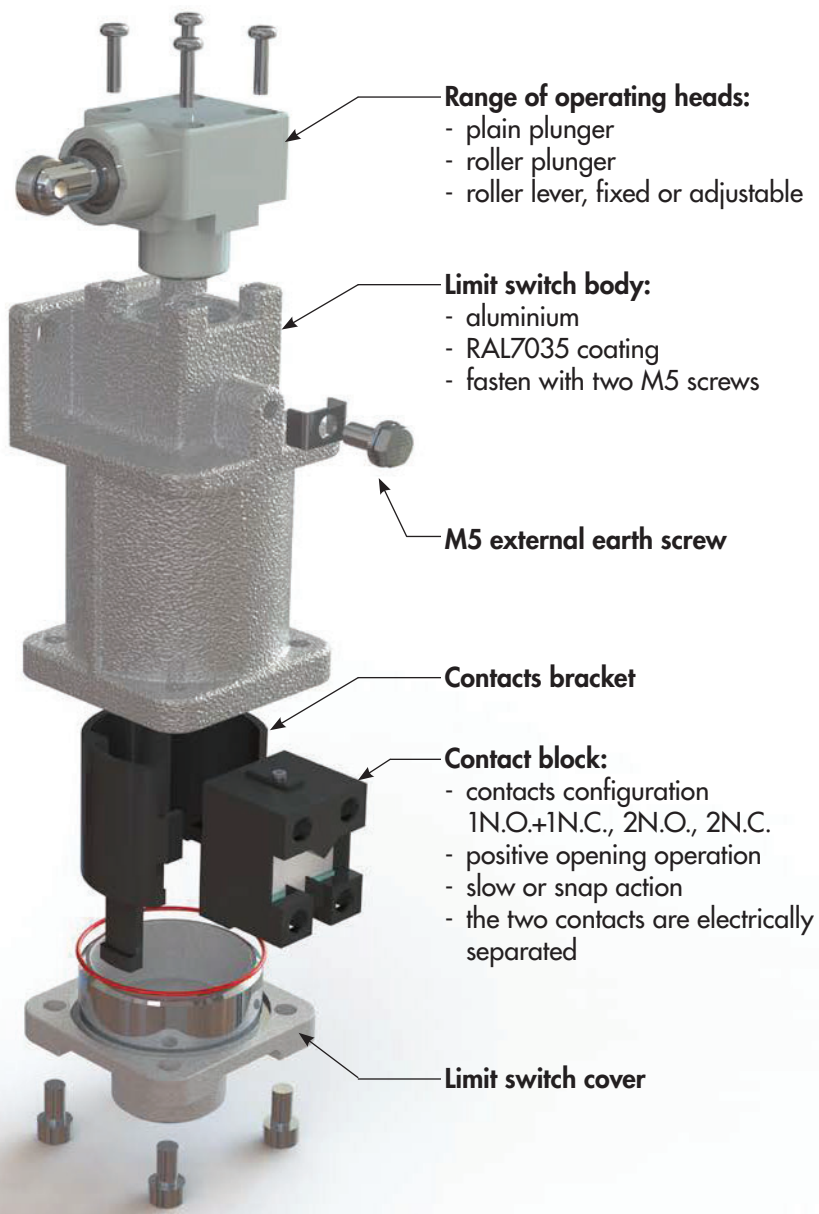
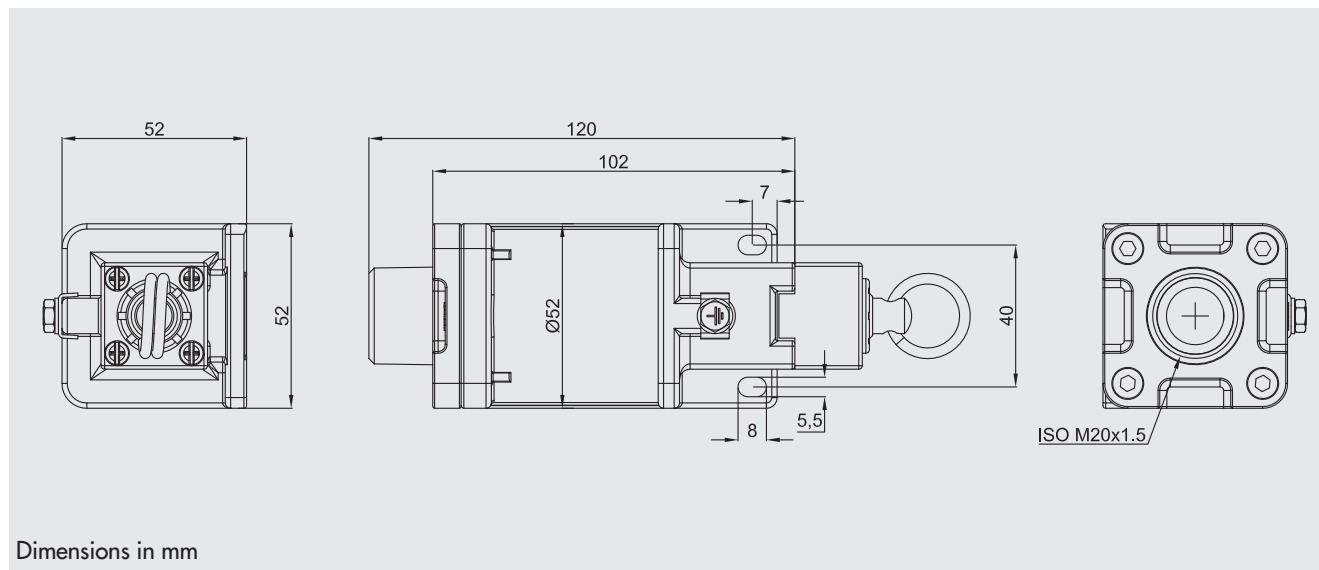



TERMINOLOGY

Positive opening operation

A control switch, with one or more break-contact elements, has a positive opening operation when the switch actuator (C) ensures the full opening of the contacts. For the part of travel that separates the contacts, there must be a positive zone with no resilient elements (e.g.: springs) between the moving contacts and the point where the actuator force is applied. The positive opening operation does not deal with N.O. contacts.

Control switches with positive opening operation may be provided with snap-action or slow-action contact elements. To use several contacts on the same control switch with positive opening operation, they must be electrically separated from each other; if not, only one contact may be used.

Snap action

Snap action contacts are characterised by a release position that is distinct from the operating position. The opening (or closure) of snap-action contacts is independent of the switch actuator speed and contributes to regular electric performance, even for slow switch actuator speeds.

Slow action

Slow-action contacts have a release position that is the same as the operating position. The switch actuator speed directly conditions the travel speed of contacts.

Minimum actuation force / torque

The minimum amount of force/torque that is to be applied to the switch actuator to produce a change in contact position.

Minimum force/torque to achieve positive opening operation

The minimum amount of force/torque that is to be applied to the switch actuator to ensure positive opening operation of the N.C. contact.

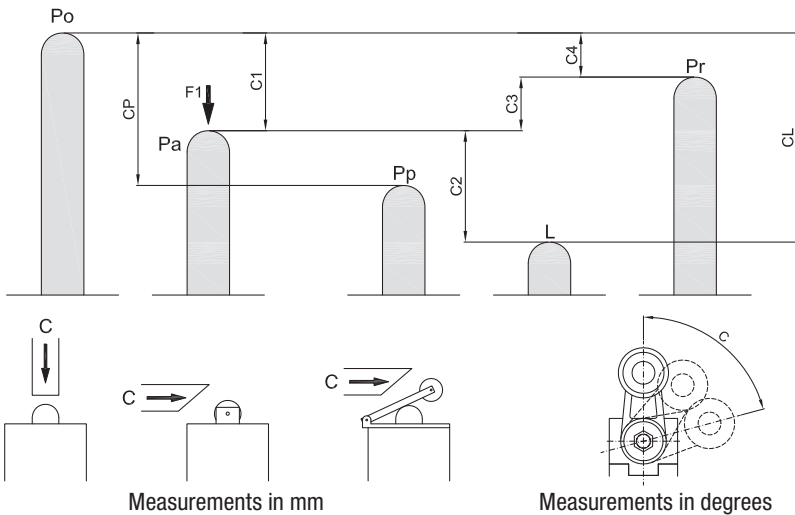

Po Free position

Position of the switch actuator when no external force is exerted on it.

Pa Operating position

Position of the switch actuator, under the effect of force F_1 , when the contacts leave their initial free position.

Pp Positive opening position

Position of the switch actuator from which positive opening operation is ensured.

L Max. travel position

Maximum acceptable travel position of the switch actuator under the effect of a force F_1 .

Pr Release position

Position of the switch actuator when the contacts return to their initial free position.

Travel for snap action contacts

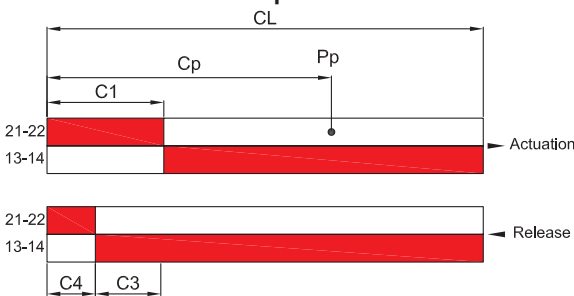

C1 Pre-travel

Distance between the free position P_o and the operating position P_a .

Cp Positive opening travel

Minimum travel of the switch actuator, from the free position P_o , to ensure positive opening operation of the N.C. contacts.

C2 Max. travel

Distance between the operating position P_a and the max. travel position L .

CL Max. travel

Distance between the free position P_o and the max. travel position L .

C3 Differential travel (C1-C4)

Travel difference between P_a and P_r .

C4 Release travel

Distance between P_r and P_o .

Travel for non-overlapping slow-action contacts

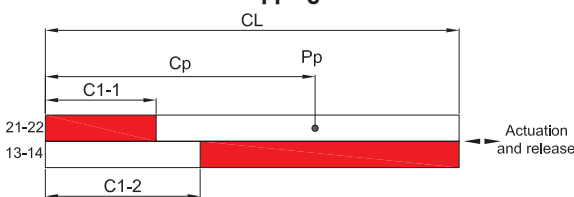

For slow-action contacts:

$C_3 = 0$

C_{1-1} = pre-travel of contacts 21-22





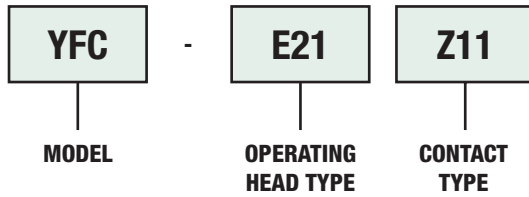







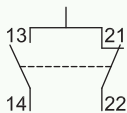

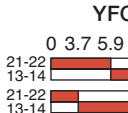
C_{1-2} = pre-travel of contacts 13-14

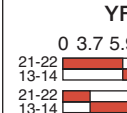
Sample order code

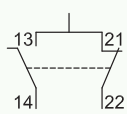
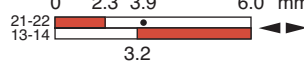
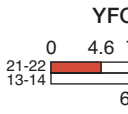
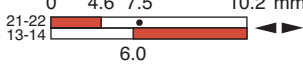
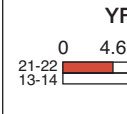
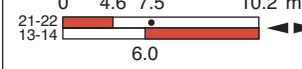
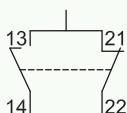
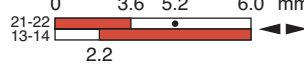
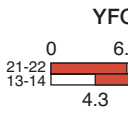
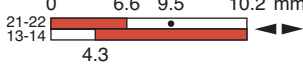
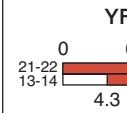
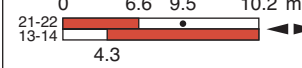
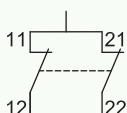
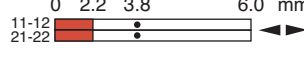
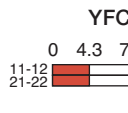
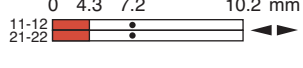
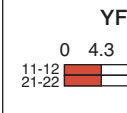
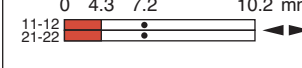
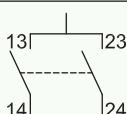

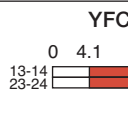
Limit switch with stainless steel lateral plain plunger and snap-action contact (1N.O. + 1N.C.)

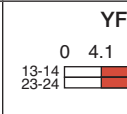

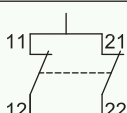
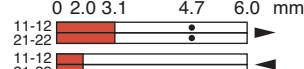
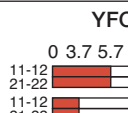
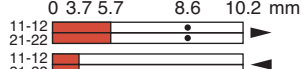
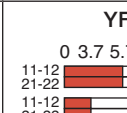
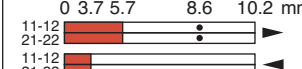
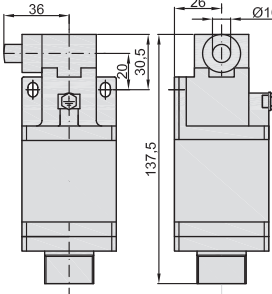
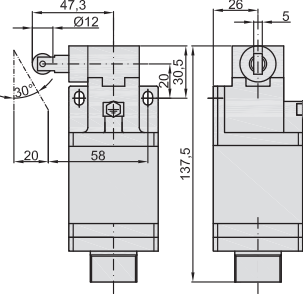
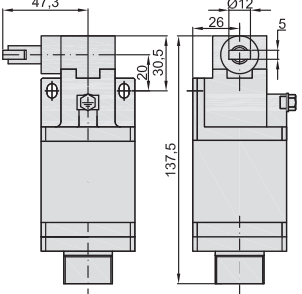











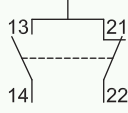

CODE SELECTION TABLE

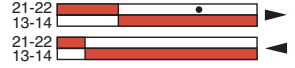
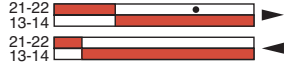
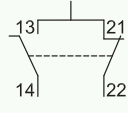
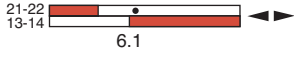
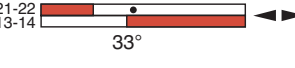
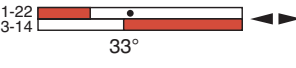
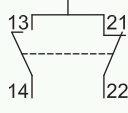
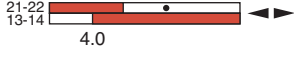
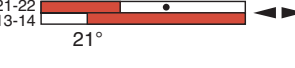
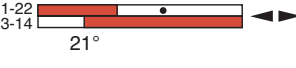
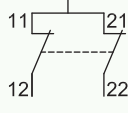
OPERATING HEAD MODEL	E21 Stainless steel lateral plain plunger	E22 Stainless steel lateral plunger with Ø12 vertical roller	E23 Stainless steel lateral plunger with Ø12 horizontal roller
Compliance / (positive opening operation N.C. contacts)	EN 50041 	EN 50041 	EN 50041 
Max. control speed [m/s]	0.5	0.5	0.5
Minimum actuation force [N] or torque [Nm]	30 / 50	30 / 50	30 / 50
CONTACT TYPE			
Z11 Snap-action contacts (1N.O.+1N.C.)	 <p style="text-align: center;">YFC-E21Z11</p> <p style="text-align: center;">0 2.0 3.2 4.8 6.0 mm</p> 	 <p style="text-align: center;">YFC-E22Z11</p> <p style="text-align: center;">0 3.7 5.9 8.8 10.2 mm</p> 	 <p style="text-align: center;">YFC-E23Z11</p> <p style="text-align: center;">0 3.7 5.9 8.8 10.2 mm</p> 
X11 Non-overlapping slow-action contacts (1N.O.+1N.C.)	 <p style="text-align: center;">YFC-E21X11</p> <p style="text-align: center;">0 2.3 3.9 6.0 mm</p> 	 <p style="text-align: center;">YFC-E22X11</p> <p style="text-align: center;">0 4.6 7.5 10.2 mm</p> 	 <p style="text-align: center;">YFC-E23X11</p> <p style="text-align: center;">0 4.6 7.5 10.2 mm</p> 
Y11 Non-overlapping slow-action contacts (1N.O.+1N.C.)	 <p style="text-align: center;">YFC-E21Y11</p> <p style="text-align: center;">0 3.6 5.2 6.0 mm</p> 	 <p style="text-align: center;">YFC-E22Y11</p> <p style="text-align: center;">0 6.6 9.5 10.2 mm</p> 	 <p style="text-align: center;">YFC-E23Y11</p> <p style="text-align: center;">0 6.6 9.5 10.2 mm</p> 
W02 Slow-action contacts (2N.C.)	 <p style="text-align: center;">YFC-E21W02</p> <p style="text-align: center;">0 2.2 3.8 6.0 mm</p> 	 <p style="text-align: center;">YFC-E22W02</p> <p style="text-align: center;">0 4.3 7.2 10.2 mm</p> 	 <p style="text-align: center;">YFC-E23W02</p> <p style="text-align: center;">0 4.3 7.2 10.2 mm</p> 
W20 Slow-action contacts (2N.O.)	 <p style="text-align: center;">YFC-E21W20</p> <p style="text-align: center;">0 2.1 6.0 mm</p> 	 <p style="text-align: center;">YFC-E22W20</p> <p style="text-align: center;">0 4.1 10.2 mm</p> 	 <p style="text-align: center;">YFC-E23W20</p> <p style="text-align: center;">0 4.1 10.2 mm</p> 
Z02 Slow-action contacts (2N.O.)	 <p style="text-align: center;">YFC-E21Z02</p> <p style="text-align: center;">0 2.0 3.1 4.7 6.0 mm</p> 	 <p style="text-align: center;">YFC-E22Z02</p> <p style="text-align: center;">0 3.7 5.7 8.6 10.2 mm</p> 	 <p style="text-align: center;">YFC-E23Z02</p> <p style="text-align: center;">0 3.7 5.7 8.6 10.2 mm</p> 
DIMENSIONS (mm)			

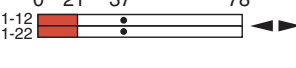
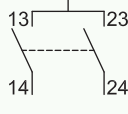



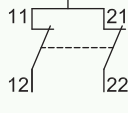
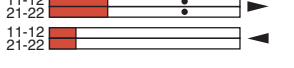

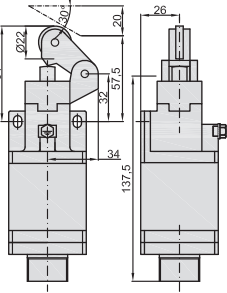
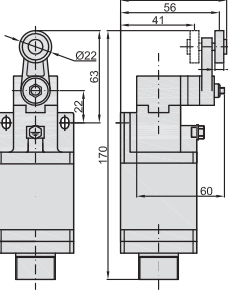
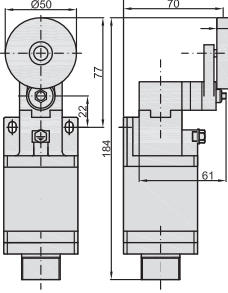











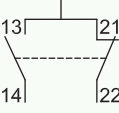

YFC Series Limit switch

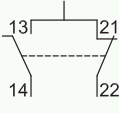
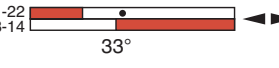
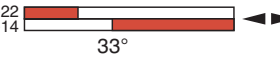
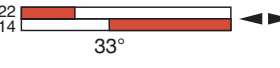
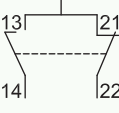
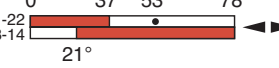
CODE SELECTION TABLE

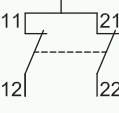
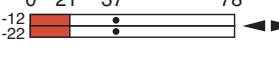
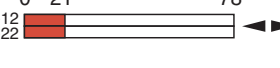
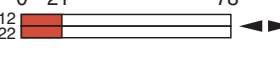
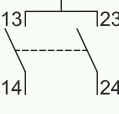
OPERATING HEAD MODEL	E3.. One way lever Ø22 E31: nylon roller E32: stainless steel roller E33: steel bearing 	E4.. Lever with Ø22 roller E41: nylon roller E42: stainless steel roller E43: steel bearing 	E44 Lever with Ø50 rubber roller 
Compliance / (positive opening operation N.C. contacts)	EN 50041 	EN 50041 	EN 50041 
Max. control speed [m/s]	1.5	1.5	1.5
Minimum actuation force [N] or torque [Nm]	12 / 40	0.15 / 0.30	0.15 / 0.30
CONTACT TYPE			
Z11 Snap-action contacts (1N.O.+1N.C.) 	YFC-E3.Z11 0 3.1 6.3 10.8 15.5 mm 	YFC-E4.Z11 0 20° 33° 49° 78° 	YFC-E4.Z11 0 20° 33° 49° 78° 
X11 Non-overlapping slow-action contacts (1N.O.+1N.C.) 	YFC-E3.X11 0 4.5 9.0 15.5 mm 6.1 	YFC-E4.X11 0 22° 38° 78° 33° 	YFC-E4.X11 0 22° 38° 78° 33° 
Y11 Non-overlapping slow-action contacts (1N.O.+1N.C.) 	YFC-E3.Y11 0 7.2 11.7 15.5 mm 4.0 	YFC-E4.Y11 0 37° 53° 78° 21° 	YFC-E4.Y11 0 37° 53° 78° 21° 
W02 Slow-action contacts (2N.C.) 	YFC-E3.W02 0 4.0 9.5 15.5 mm 	YFC-E4.W02 0 21° 37° 78° 	YFC-E4.W02 0 21° 37° 78° 
W20 Slow-action contacts (2N.O.) 	YFC-E3.W20 0 3.6 15.5 mm 	YFC-E22W20 0 20° 78° 	YFC-E4.W20 0 20° 78° 
Z02 Slow-action contacts (2N.O.) 	YFC-E3.Z02 0 3.1 6.1 10.6 15.5 mm 	YFC-E4.Z02 0 20° 32° 48° 78° 	YFC-E4.Z02 0 20° 32° 48° 78° 
DIMENSIONS (mm)			



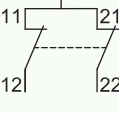

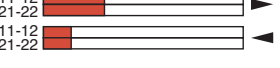
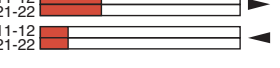
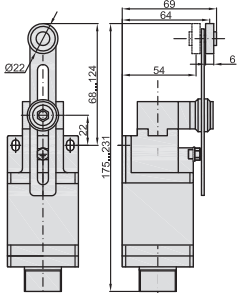
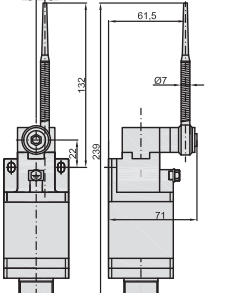
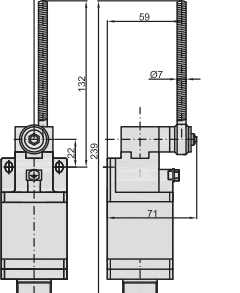







CODE SELECTION TABLE

OPERATING HEAD MODEL	E5. One way lever Ø22 E51: nylon roller E52: stainless steel roller E53: steel bearing 	E61 Nylon actuator with a stainless steel spring 	E62 Stainless steel spring actuator 
Compliance / (positive opening operation N.C. contacts)	EN 50041 	EN 50041 	EN 50041 
Max. control speed [m/s]	1.5	1.5	1.5
Minimum actuation force [N] or torque [Nm]	0.15 / 0.30	0.15 / -	0.15 / -
CONTACT TYPE			
Z11 Snap-action contacts (1N.O.+1N.C.) 	YFC-E5.Z11 0 20° 33° 49° 78° 	YFC-E61Z11 0 20° 33° 78° 	YFC-E62Z11 0 20° 33° 78° 
X11 Non-overlapping slow-action contacts (1N.O.+1N.C.) 	YFC-E5.X11 0 22° 38° 78° 21-22 33° 	YFC-E61X11 0 22° 78° 21-22 33° 	YFC-E62X11 0 22° 78° 21-22 33° 
Y11 Non-overlapping slow-action contacts (1N.O.+1N.C.) 	YFC-E5.Y11 0 37° 53° 78° 21-22 21° 	YFC-E61Y11 0 37° 78° 21-22 21° 	YFC-E62Y11 0 37° 78° 21-22 21° 
W02 Slow-action contacts (2N.C.) 	YFC-E5.W02 0 21° 37° 78° 11-12 21-22 	YFC-E61W02 0 21° 78° 11-12 21-22 	YFC-E62W02 0 21° 78° 11-12 21-22 
W20 Slow-action contacts (2N.O.) 	YFC-E5.W20 0 20° 78° 13-14 23-24 	YFC-E61W20 0 20° 78° 13-14 23-24 	YFC-E62W20 0 20° 78° 13-14 23-24 
Z02 Slow-action contacts (2N.O.) 	YFC-E5.Z02 0 20° 32° 48° 78° 11-12 21-22 	YFC-E61Z02 0 20° 32° 78° 11-12 21-22 	YFC-E62Z02 0 20° 32° 78° 11-12 21-22 
DIMENSIONS (mm)			



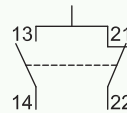
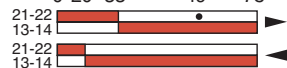
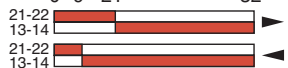
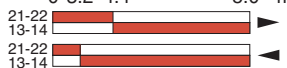
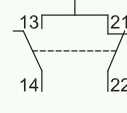
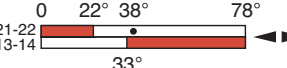
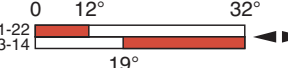
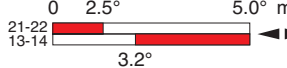
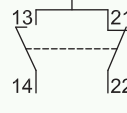
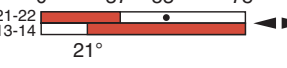
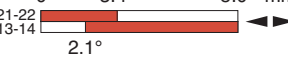
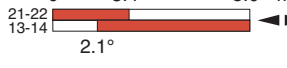
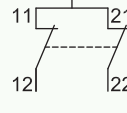
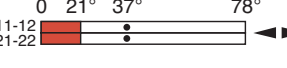
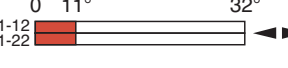
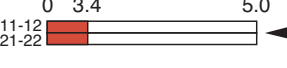
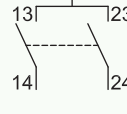

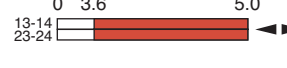
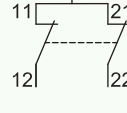

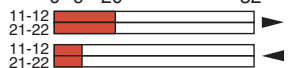
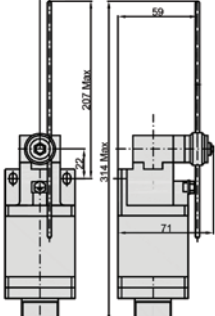
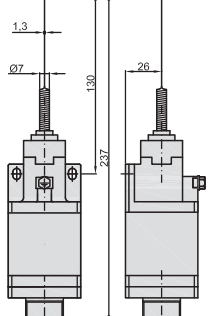
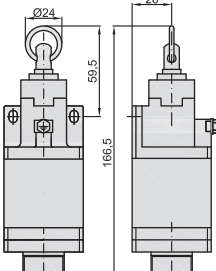











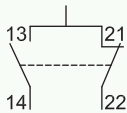
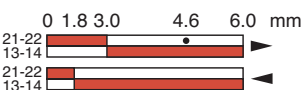

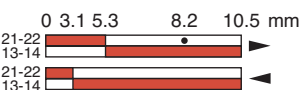
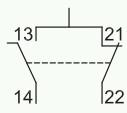
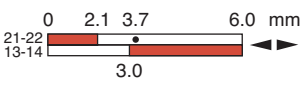
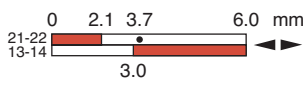
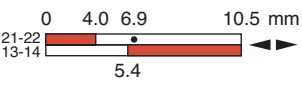
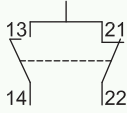
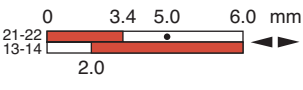
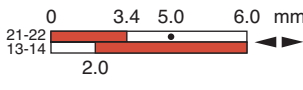
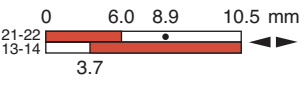
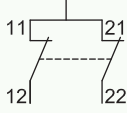

YFC Series Limit switch

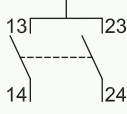
CODE SELECTION TABLE

OPERATING HEAD MODEL	E7.. Adjustable rod lever E71: stainless steel rod Ø3 E72: nylon rod Ø6 E73: fibreglass rod Ø3 E75: metal rod 3x3 	E91 Multi-directional stainless steel spring actuator 	E99 Pull action with ring 
Compliance / (positive opening operation N.C. contacts)	EN 50041 	EN 50041 	EN 50041 
Max. control speed [m/s]	1.5	1	0.5
Minimum actuation force [N] or torque [Nm]	0.15 / 0.30	0.18 / -	25 / -
CONTACT TYPE			
Z11 Snap-action contacts (1N.O.+1N.C.) 	YFC-E7.Z11 0 20° 33° 49° 78° 	YFC-E91Z11 0 9° 21° 32° 	YFC-E99Z11 0 3.2° 4.4° 5.0° mm 
X11 Non-overlapping slow-action contacts (1N.O.+1N.C.) 	YFC-E7.X11 0 22° 38° 78° 21-22 33° 	YFC-E91X11 0 12° 32° 21-22 19° 	YFC-E99X11 0 2.5° 5.0° mm 21-22 3.2° 
Y11 Non-overlapping slow-action contacts (1N.O.+1N.C.) 	YFC-E7.Y11 0 37° 53° 78° 21-22 21° 	YFC-E91Y11 0 3.4° 5.0° mm 21-22 2.1° 	YFC-E99Y11 0 3.4° 5.0° mm 21-22 2.1° 
W02 Slow-action contacts (2N.C.) 	YFC-E7.W02 0 21° 37° 78° 11-12 21-22 	YFC-E91W02 0 11° 32° 11-12 21-22 	YFC-E99W02 0 3.4 5.0 11-12 21-22 
W20 Slow-action contacts (2N.O.) 	YFC-E7.W20 0 20° 78° 13-14 23-24 	YFC-E91W20 0 10° 32° 13-14 23-24 	YFC-E99W20 0 3.6 5.0 13-14 23-24 
Z02 Slow-action contacts (2N.O.) 	YFC-E7.Z02 0 20° 32° 48° 78° 11-12 21-22 	YFC-E91Z02 0 9° 20° 32° 11-12 21-22 	
DIMENSIONS (mm)			

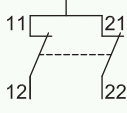

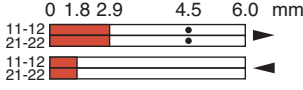
CODE SELECTION TABLE

OPERATING HEAD MODEL	E11 Stainless steel plain plunger 	E12 Stainless steel ball plunger 	E13 Stainless steel roller plunger Ø12 
Compliance / (positive opening operation N.C. contacts)	EN 50041 	EN 50041 	EN 50041 
Max. control speed [m/s]	0.5	0.5	0.5
Minimum actuation force or torque	30 / 45	30 / 45	22 / 40
CONTACT TYPE			
Z11 Snap-action contacts (1N.O.+1N.C.) 	YFC-E11Z11 	YFC-E12Z11 	YFC-E13Z11 
X11 Non-overlapping slow-action contacts (1N.O.+1N.C.) 	YFC-E11X11 	YFC-E61X11 	YFC-E13X11 
Y11 Non-overlapping slow-action contacts (1N.O.+1N.C.) 	YFC-E11Y11 	YFC-E61Y11 	YFC-E13Y11 
W02 Slow-action contacts (2N.C.) 	YFC-E11W02 	YFC-E61W02 	YFC-E13W02 
W20 Slow-action contacts (2N.O.) 	YFC-E11W20 	YFC-E61W20 	YFC-E13W20 
Z02 Slow-action contacts (2N.O.) 	YFC-E11Z02 	YFC-E61Z02 	YFC-E13Z02 
DIMENSIONS (mm)	